

Inhalt

1. Bestimmungsgemäße Verwendung	1
2. Lieferumfang	1
3.1 Varianten	2
3.2 Abmessungen	2
4. Technische Daten	3
4.1 Allgemein	3
4.2 Elektrische Kenndaten PY L-S-TL	3
4.3 Elektrische Kenndaten PY L-S-TLA (Schallgeberteil)	3
5. Zulassungen	4
6. Inbetriebnahme	4
6.1 Sicherheitshinweise	4
6.2 Elektrischer Anschluss	6
6.3 Einstellung der optischen Betriebsarten	6
6.4 Toneinstellungen	7
7. Zubehör	7
8. Wartung, Service, Instandhaltung	7
9. Außerbetriebnahme, Demontage und Entsorgung	7

1. Bestimmungsgemäße Verwendung

LED-Ampelleuchten der PYRA - Serie sind für die Signalisierung von z.B. Gefahrzuständen in Industrie, Gewerbe und Gebäudebereichen bestimmt.

Die LED im Leuchtenteil kann in verschiedenen Betriebsarten betrieben werden, die mithilfe eines internen Schalters eingestellt werden können.

Die PY-TLA-Versionen mit integriertem Schallgeber-Modul bieten zusätzlich die Möglichkeit der akustischen Signalisierung mit 80 verschiedenen Tonarten. Die Töne können mithilfe eines internen Schalters im Schallgeberoberteil eingestellt werden.

Die Geräte nur in unbeschädigtem Zustand innerhalb der spezifizierten Kenndaten betreiben. Die Funktion des Gerätes ist nur gewährleistet, wenn Ober- und Unterteil korrekt zusammengefügt sind.

Die Geräte sind für den Einsatz im Innen- und Außenbereich geeignet und nur für die ortsfeste Montage bestimmt.

2. Lieferumfang

Der Lieferumfang besteht aus:

1x Signalgerät (vorkonfektioniert)
oder

1x Unterteil PY L-S-TL (2, 3, 4-stufig) + passende Hauben bzw. Schallgeber-Oberteile

1x Membrannippel M20

(Option: Kabelverschraubung/ M12-Stecker)

1x Kurzanleitung

3.1 Varianten

Vorkonfektioniert:
mit
Standardfarbreihenfolge

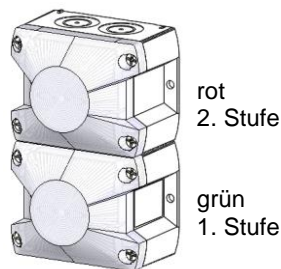

PY L-S-TL-2

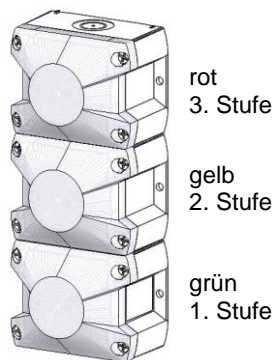

PY L-S-TL-3

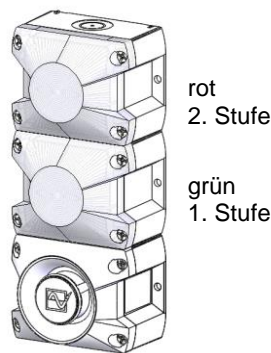

PY L-S-TLA-3

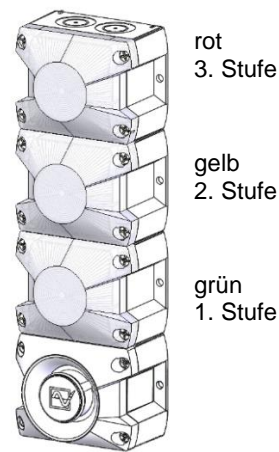

PY L-S-TLA-4

Freie Farbwahl:

Beispiel
PY L-S-TLA-4

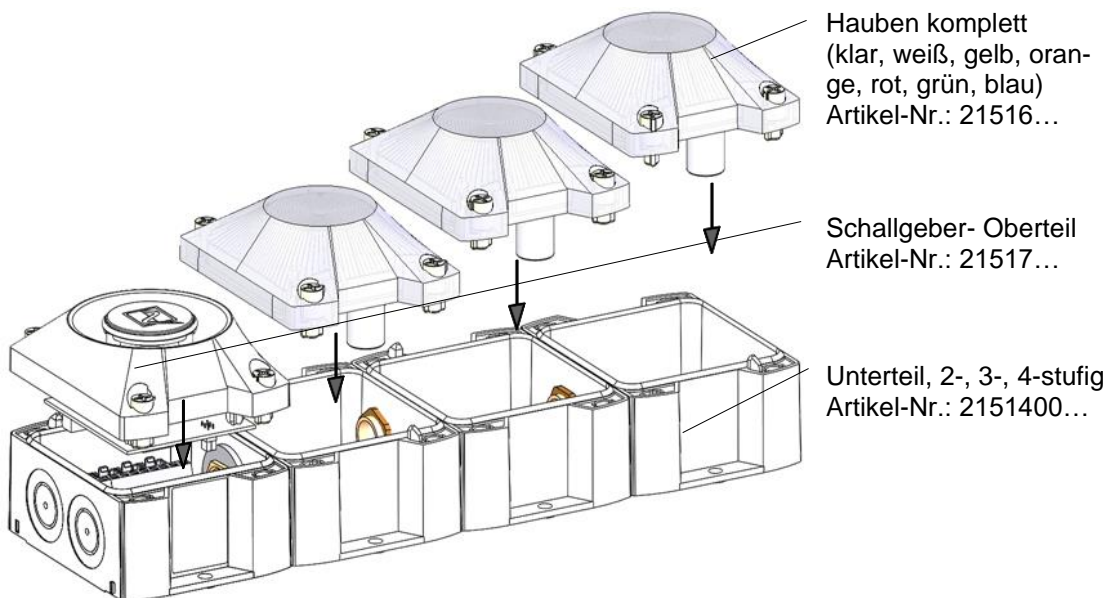

3.2 Abmessungen

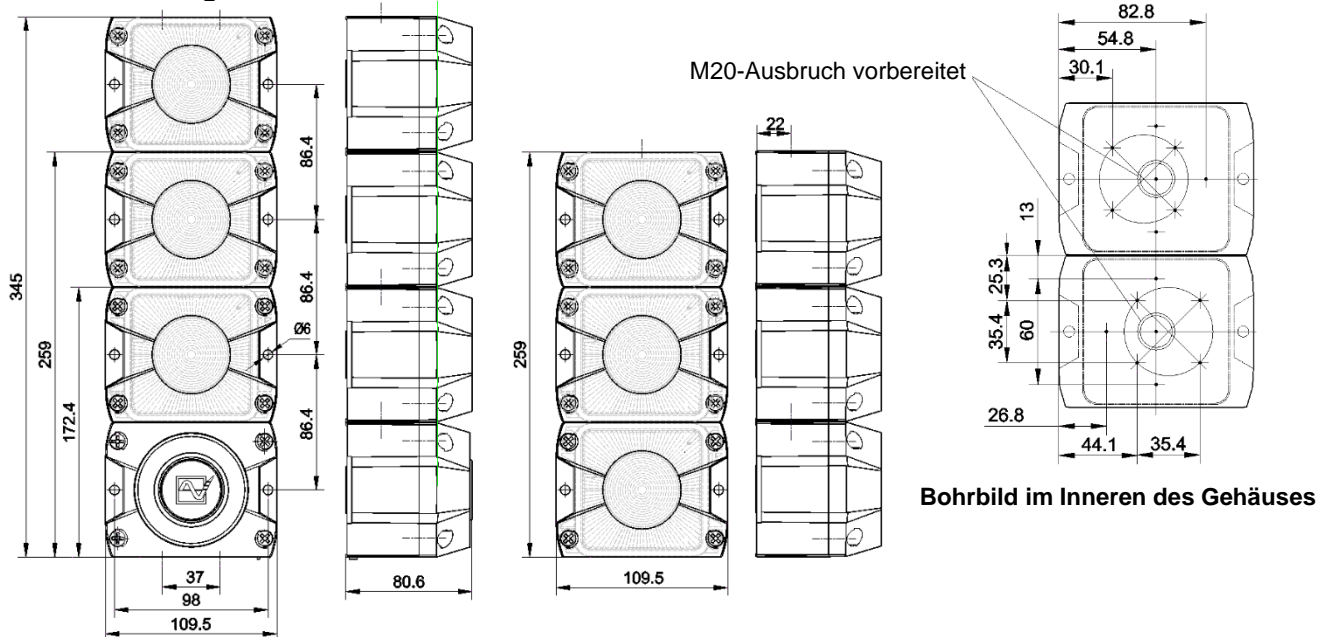

4. Technische Daten

4.1 Allgemein

	PY L-S-TL	PY L-S-TLA
Max. Schallpegel	--	105 dB (A) 1m
Lautstärkeregelung	--	max. -12 dB
Töne	--	80
Lichtstärke	76 cd (klar)	
Leuchtmittel	1x Hochleistungs-LED/ Stufe	
Einschaltdauer	100%	
Anschlussklemmen	0,14 - 2,5mm ² feindrätig / AWG24 - AWG 14	
Schutzart	IP 66 (EN 60529), Type 4 & 4x	
Schlagfestigkeit	IK08 (EN 50102)	
Schutzklasse	II	
Betriebstemperatur	-40 °C...+55 °C	
Lagertemperatur	-40 °C...+70 °C	
Max. rel. Luftfeuchte	90%	
Kabeleinführung	4-stufig: 8x M20 vorgeprägt 2 und 3-stufig: 6x M20 vorgeprägt	
Dichtbereich der Durchführungsstülle	7 – 13 mm Bei Verwendung von Kabeldurchmessern < 7 mm eine Kabelverschraubung mit ausreichender Schutzart vorsehen	
Gehäusematerial	PC/ ABS Blend	
Haubenmaterial	PC	
Einbaulage	beliebig	
Haubenfarben	klar, weiß, gelb, orange, rot, grün, blau	

4.2 Elektrische Kenndaten PY L-S-TL

Bemessungsspannungsbereich (Begrenzungen siehe Zulassungen)	12 – 48V DC			24 V AC 50/ 60 Hz	115 – 230 V AC 50/ 60 Hz 120 V DC		
Arbeitsspannungsbereich	10 – 60 V DC			21,6 – 26,4 V AC	90 – 265 V AC 108 – 132V DC		
Bemessungsstromaufnahme / Stufe (max)	12 V DC	24 V DC	48 V DC	167 mA	120V DC	115V AC	230V AC
	275 mA	120 mA	65 mA		74,4 mA	51 mA	36 mA
Leistungsaufnahme / Stufe (max)	3,3 W	2,9 W	3,1 W	4 VA	2,93 W	5,9 VA	8,3 VA

4.3 Elektrische Kenndaten PY L-S-TLA (Schallgeberteil)

Bemessungsspannungsbereich (Begrenzungen siehe Zulassungen)	12 V – 48 V DC	24 V AC 50/ 60 Hz	115 V AC 50/ 60 Hz	230V AC 50/ 60 Hz
Arbeitsspannungsbereich	10 – 57 V DC	21,6 – 26,4 V AC	95 – 127 V AC	195 – 253 V AC
Bemessungsstromaufnahme Schallgeberteil (max)	24 V DC: 80 mA	150 mA	30 mA	16 mA
Leistungsaufnahme Schallgeberteil (max)	12 – 48 V: 4 W 24 V: 2W	4,5 VA	4,5 VA	4,5 VA

5. Zulassungen

(Zulassungen gelten für gekennzeichnete Geräte)

UL, cUL	E189090 UCST, UCST7, ULSZ, ULSZ7, UEES, UEES7 (weiterführende Informationen siehe Seite 4 im englischsprachigen Kapitel)
---------	--

6. Inbetriebnahme

6.1 Sicherheitshinweise

	<p>GEFAHR - Lebensgefahr durch Stromschlag Spannungsführende Geräte und freiliegende Anschlussleitungen können Stromschläge erzeugen und schwere Unfälle verursachen.</p> <ul style="list-style-type: none"> ➤ Arbeiten an elektrischen Anschlüssen dürfen nur elektrotechnisch geschulte und autorisierte Fachkräfte durchführen. ➤ Vor der Montage alle Zuleitungen spannungsfrei schalten und gegen Wiedereinschalten sichern. Spannungsfreiheit immer sicherstellen. ➤ Entladungsphase von 5 Minuten für die elektrischen Komponenten abwarten. Erst danach Gerät öffnen. ➤ Das Anlegen der Betriebsspannung darf nur bei fest verschlossenem Gehäuse erfolgen.
	<p>WARNUNG - Gefahr durch unzulässigen Einsatz der Geräte Der nicht bestimmungsgemäße Einsatz kann zu schweren Unfällen führen.</p> <ul style="list-style-type: none"> ➤ Bei der Installation darauf achten, dass die Anschlussleitung gegen Zug und Verdrehen abgesichert ist. Die Geräte sind nur für die ortsfeste Montage bestimmt. <p>Zur Gewährleistung der dauerhaften Funktion:</p> <ul style="list-style-type: none"> ➤ in staubreicher Umgebung oder im Außenbereich den Schalltrichter nicht nach oben gerichtet montieren.
	<p>GEFAHR - Gefahr durch Beschädigung der Geräte Nichtbeachtung der Typenschild-Angaben kann zu schweren Unfällen führen.</p> <ul style="list-style-type: none"> ➤ Bei Installation und Wartung der Geräte immer die Angaben auf dem Typenschild beachten.
	<p>VORSICHT - Verletzungsgefahr durch scharfe Kanten oder erhitzte Bauteile</p> <ul style="list-style-type: none"> ➤ Bei Installations-, Montage-, oder Service-/ Wartungsarbeiten Handschuhe tragen. ➤ Verdrahtung entfernt von scharfen Kanten, Ecken und internen Komponenten vornehmen.
	<p>VORSICHT – Beeinträchtigung des Sehvermögens</p> <ul style="list-style-type: none"> ➤ Um eine Beeinträchtigung des Sehvermögens zu verhindern, den dauernden, direkten Blick in die aktivierte Leuchte vermeiden. <p>VORSICHT - Beeinträchtigung des Hörvermögens</p> <ul style="list-style-type: none"> ➤ Um eine Beeinträchtigung des Hörvermögens zu verhindern, bei Arbeiten/ Tests eine Schallschutzausrüstung tragen.

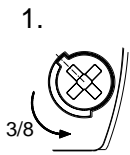
Öffnen des Gehäuses

Durch Lösen der vier Deckelschrauben lässt sich das Oberteil abnehmen

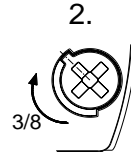
Verschließen des Gehäuses

Verschließen des Gehäuses durch Drehen der Deckelschrauben in die Endstellung bis zur Verrastung.

Das Gerät wird in nicht verschlossenem Zustand ausgeliefert. Plombierstopfen für die Gehäuseschrauben sind als Zubehör erhältlich.

Kabeldurchführungen

Der mitgelieferte Membrannippel kann durch eine Kabelverschraubung oder durch einen M12-Steckverbinder mit einem Flanschmaß von M20 ersetzt werden.

- Nur Kabelverschraubungen mit einer Schutzart von mindestens IP66 an den entsprechenden Durchbrüchen montieren.

Bei Kabeldurchmessern von <7 mm eine Kabelverschraubung mit ausreichender Schutzart verwenden.

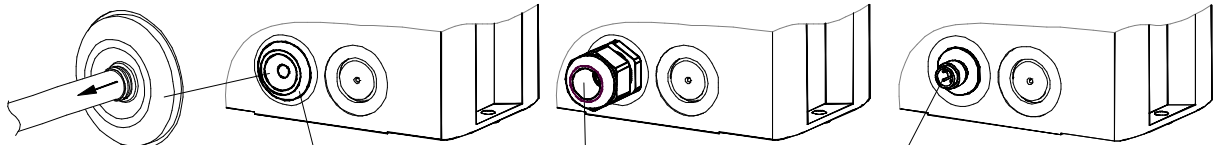

IP 66 nur bei nach außen gerichtetem Trichter der Membrane.

Membrannippel IP 66 (mitgeliefert)

Kabelverschraubung IP 66 (Option)

M12- Steckverbinder IP 66, für Kleinspannungs-Geräte (Option)

Nach Montage des Kabels Reste der Membrane entfernen.

6.2 Elektrischer Anschluss

➤ **Sicherheitshinweise** beachten!

Anschlussplatine im Unterteil:

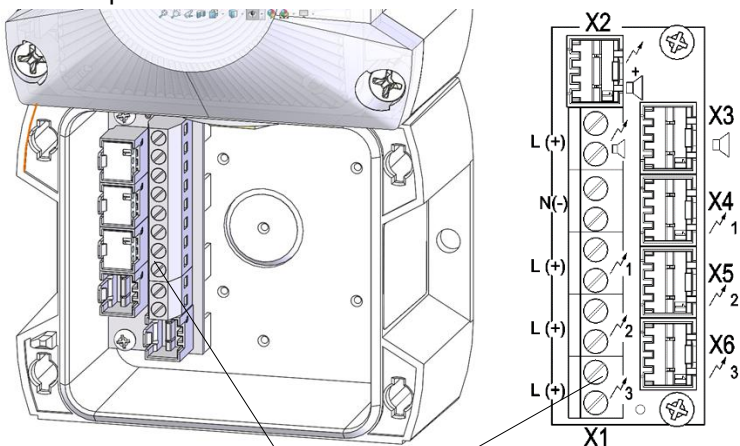

Anschlussklemme (X1)

- X1** Betriebsspannungsanschluss
- X2** Steckanschluss Leuchte bei kombiniertem Betrieb mit Schallgeber
- X3** Steckanschluss Schallgeber
- X4** Steckanschluss 1. Stufe
- X5** Steckanschluss 2. Stufe
- X6** Steckanschluss 3. Stufe

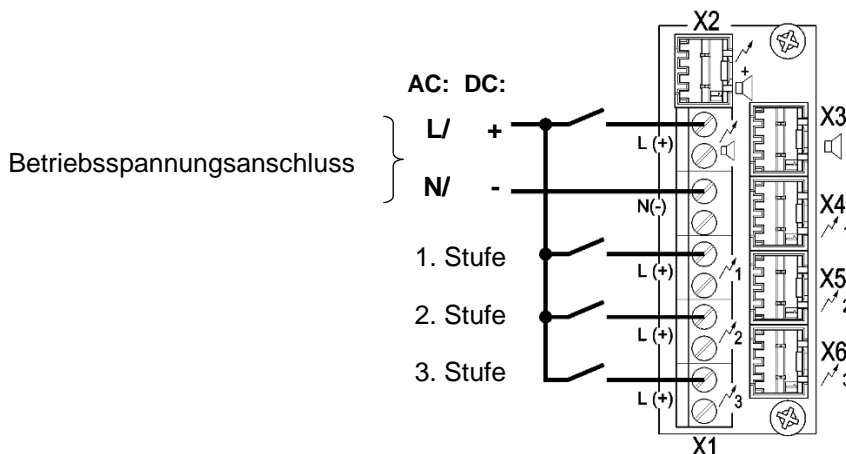

Betriebsspannungsanschluss

Hinweis: Geräte mit DC-Spannung sind mit einem Verpolungsschutz ausgerüstet. Bei Verpolung der Anschlüsse keine Funktion.

6.3 Einstellung der optischen Betriebsarten

Platine in der Haube:

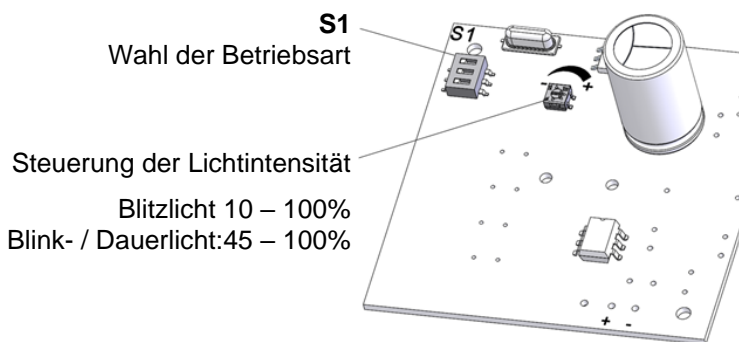

S1			Betriebsart
1	2	3	
OFF	OFF	OFF	Blitzlicht 1 Hz *
OFF	OFF	ON	Blitzlicht 0,75 Hz
OFF	ON	OFF	Dauerlicht
OFF	ON	ON	Blinklicht 1 Hz
ON	OFF	OFF	Blitzlicht 2 Hz
ON	OFF	ON	Blinklicht 2 Hz
ON	ON	OFF	Blitzlicht 0,1 Hz
ON	ON	ON	Blitzlicht 0,5 Hz

* Werkseinstellung

6.4 Toneinstellungen

Der gewünschte Ton wird mit dem Tonartenschalter **S3** auf der Treiberplatine im Schallgeber-Oberteil ausgewählt. Die möglichen Töne sind in der Tonartentabelle im Anhang beschrieben. Nach Anlegen der Versorgungsspannung wird der Ton erzeugt.

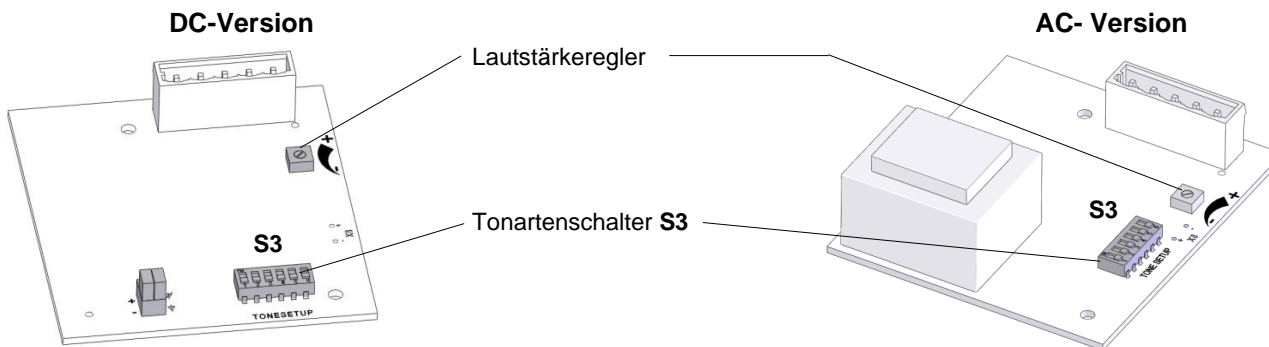

7. Zubehör

Artikel-Nr.	Bezeichnung
28300000002	Plombierstopfen, 4er-Pack
28912000000	Ersatzverriegelungsbolzen, 4er-Pack

8. Wartung, Service, Instandhaltung

- Bei allen Arbeiten am Gerät [Sicherheitshinweise](#) beachten.

Das Gerät erfordert keine besondere Wartung.

- Äußere Reinigung mit einer schwachen Seifenlösung ohne Verwendung von Lösungsmittel vornehmen.
- Austausch von Komponenten nur mit Originalersatzteilen.
- Reparaturen grundsätzlich nur im Herstellerwerk ausführen lassen.

Umbauten, Änderungen, fehlerhafter und unzulässiger Einsatz sowie die Nichtbeachtung der Hinweise dieser Betriebsanleitung schließen eine Gewährleistung aus.

9. Außerbetriebnahme, Demontage und Entsorgung

- Bei allen Arbeiten am Gerät [Sicherheitshinweise](#) beachten.
- Altgeräte nur von sachkundigen Personen und gemäß geltenden Umweltvorschriften entsorgen. Altgeräte werden ebenfalls von Pfannenberg fachgerecht entsorgt. Die Anlieferung an eines unserer Herstellwerke hat kostenfrei zu erfolgen.



Pfannenberg GmbH

Werner-Witt-Straße 1 • D- 21035 Hamburg

Tel.: +49/ (0)40/ 734 12-0

Fax: +49/ (0)40/ 734 12-101

service@pfannenberg.com

<http://www.pfannenberg.com>

Content

1. Intended use	1
2. Scope of delivery	1
3.1 Versions	2
3.2 Dimensions	2
4. Technical data	3
4.1 General	3
4.2 Electrical data PY L-S-TL.....	3
4.3 Electrical data PY L-S-TLA (Sounder part).....	3
5. Approvals	4
6. Commissioning	4
6.1 Safety information	4
6.2 Electrical connection	6
6.3 Setting the operating modes	6
6.4 Tone settings (on the driver board in the upper part)	7
7. Accessories	7
8. Maintenance, service, repairs	7
9. Decommissioning, dismantling and disposal	7

1. Intended use

LED traffic lights of the PYRA series are designed for the signaling of e.g. hazardous conditions in industry, trade and construction areas.

The LED in the light section can be operated in different modes, all of which can be activated by an internal switch.

The PY-TLA versions with integrated sounder module also have the option of acoustic signaling with 80 different tones. The tones can be selected using an internal switch in the top of the sounder.

The devices must only be operated when undamaged and within the specified parameters. The function of the device can only be guaranteed if the upper and lower parts are correctly joined together. The devices are designed for indoor and outdoor use and are only intended for fixed installation.

2. Scope of delivery

The scope of delivery consists of:

1x Signaling device (pre-assembled)

 1x lower part PY L-S-TL (2, 3 or 4 stages) + matching lenses and/or sounder upper parts

1x Diaphragm nipple M20

1x Quick guide

3.1 Versions

Pre-assembled:
With standard color
sequence

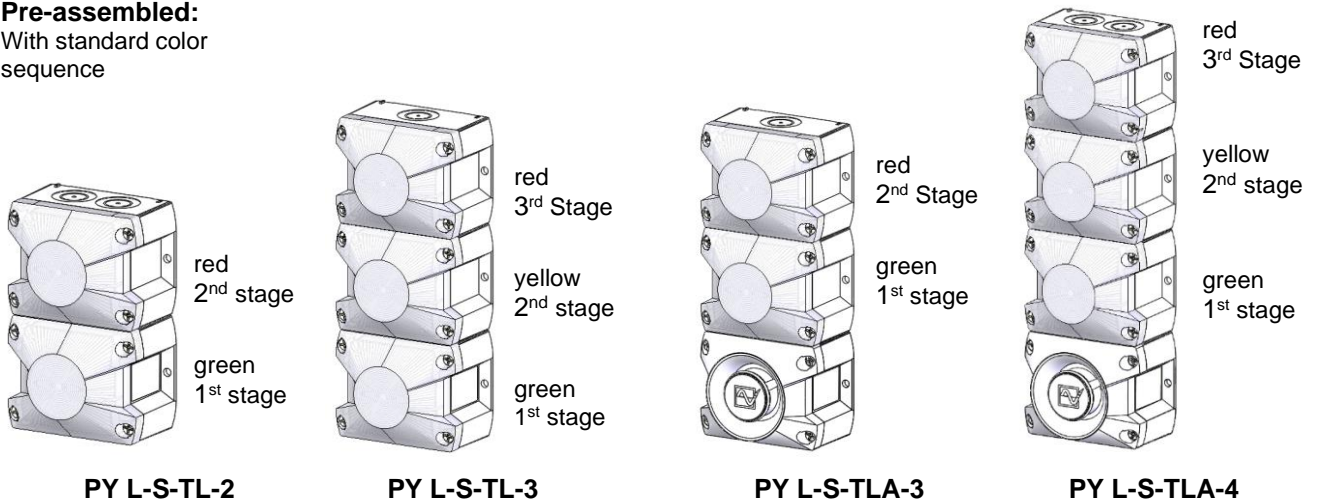

Free choice of color:

Example
PY L-S-TLA-4

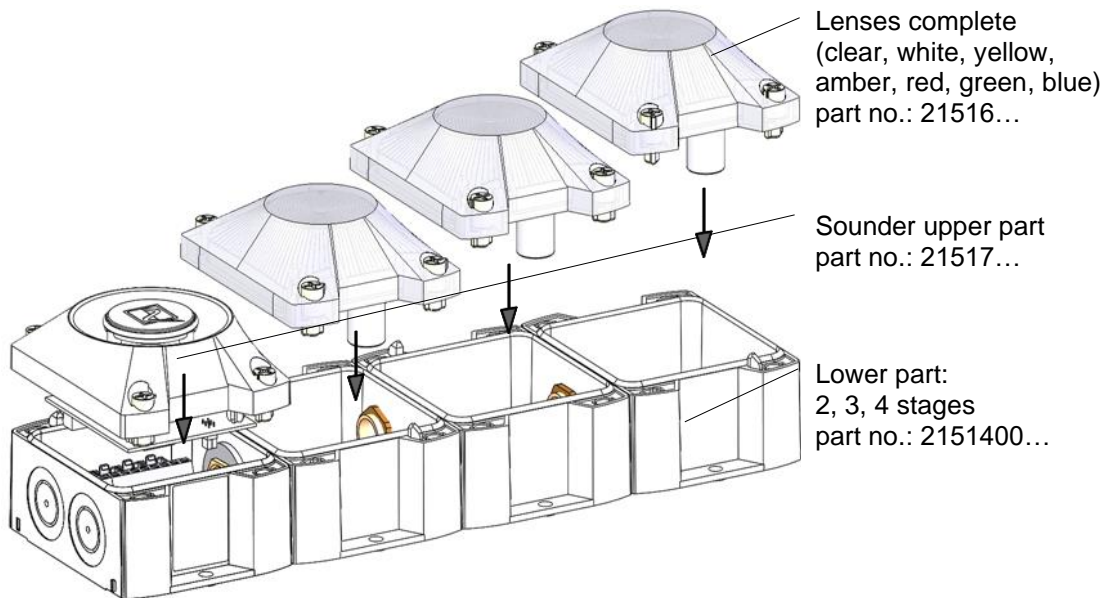

3.2 Dimensions

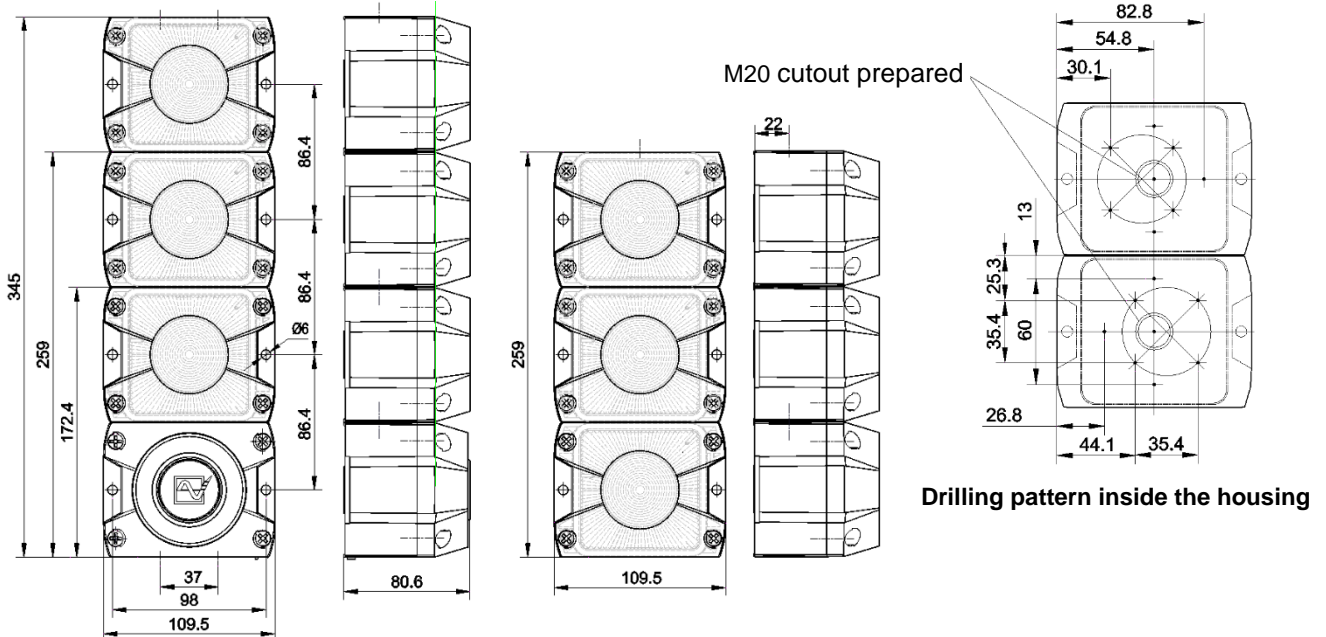

4. Technical data

4.1 General

	PY L-S-TL	PY L-S-TLA
Max. sound level	--	105 dB (A) 1m
Volume control	--	max. -12 dB
Tones	--	80
Light intensity	76 cd (clear)	
Illuminant	1x high-performance LED / Stage	
Duty cycle	100%	
Connecting terminals	0.14 - 2.5mm ² fine stranded / AWG24 - AWG 14	
Ingress protection	IP 66 (EN 60529), Type 4 & 4x	
Impact strength	IK08 (EN 50102)	
Protection class	II  double insulated equipment	
Operating temperature	-40 °C...+55 °C	
Storage temperature	-40 °C...+70 °C	
Max. rel. air humidity	90%	
Cable inlet	4-stage: 8x M20 pre-embossed 2 and 3-stage: 6x M20 pre-embossed	
Sealing range of the feed-through grommet	7 – 13 mm A cable gland with a sufficient degree of protection must be provided when cable diameters of < 7 mm are used.	
Housing material	PC/ ABS Blend	
Lens material	PC	
Installation position	any	
Lens colors	transparent, white, yellow, amber, red, green, blue	

4.2 Electrical data PY L-S-TL

Rated voltage (See approvals for limit values)	12 – 48V DC			24 V AC 50/ 60 Hz	115 - 230 V AC 50/ 60 Hz 120V DC		
Operation voltage range	10 – 60 V DC			21.6 – 26.4 V AC	90 – 265 V AC 108 –132V DC		
Rated current (max) / Stage	12 V DC	24 V DC	48 V DC	167 mA	120V DC	115V AC	230V AC
	275 mA	120 mA	65 mA		74.4 mA	51 mA	36 mA
Power consumption / Stage (max)	3.3 W	2.9 W	3.1 W	4 VA	2,93 W	5,9 VA	8.3 VA

4.3 Electrical data PY L-S-TLA (Sounder part)

Rated voltage range	12 V – 48 V DC	24 V AC 50/ 60 Hz	115 V AC 50/ 60 Hz	230V AC 50/ 60 Hz
Operation voltage range	10 – 57 V DC	21.6 – 26,4 V AC	95 – 127 V AC	195 – 253 V AC
Rated current Sounder part (max)	24 V DC: 80 mA	150 mA	30 mA	16 mA
Power consumption sounder part (max)	12 – 48 V: 4 W 24 V: 2W	4.5 VA	4.5 VA	4.5 VA





5. Approvals

(Approvals are valid for marked devices)

UL, cUL	E189090	
	Rated Voltage	Audible and Visual signal Appliance General Signal Equipment UCST, UCST7 and UEES, UEES7
	115 V AC 230 V AC 24 V AC 12 V DC 24 V DC 48 V DC	Suitable for indoor and outdoor use. Warning: Not to be used as a Visual Public Mode Alarm Notification Appliance. According to CSA-C22.2 No. 205-M1983 clause 4.3.4 the connection is limited to max. three leads.

6. Commissioning

6.1 Safety information

	<p>DANGER - Danger to life due to electric shock</p> <p>Voltage-carrying devices and exposed connection cables may cause electric shocks and serious accidents.</p> <ul style="list-style-type: none"> ➤ Only trained and authorized electricians may work on electrical connections. ➤ Disconnect all supply lines from mains before installation and secure them against reconnection. Always ensure absence of voltage. ➤ Wait for the discharge phase of 5 minutes for the electrical components. The device should only be opened afterwards. ➤ The operating voltage must only be applied when the housing is firmly closed.
	<p>WARNING - Danger due to unauthorized use of the devices</p> <p>Improper use may lead to serious accidents.</p> <ul style="list-style-type: none"> ➤ Ensure that the connection cable is protected against pulling and twisting during installation. The devices are only intended for fixed installation. <p>To ensure long-term function:</p> <ul style="list-style-type: none"> ➤ Do not mount the sound projector pointing upwards in dusty environments or outdoors.
	<p>DANGER - Danger due to damage to the devices</p> <p>Non-compliance with the information on the type plate can lead to serious accidents.</p> <ul style="list-style-type: none"> ➤ Always observe the information on the type plate when installing and maintaining the devices.
	<p>CAUTION - Risk of injury due to sharp edges or heated components</p> <ul style="list-style-type: none"> ➤ Wear gloves during any installation, assembly or service/maintenance work. ➤ Perform wiring tasks at a distance from sharp edges, corners and internal components.
	<p>CAUTION - Impairment of vision</p> <ul style="list-style-type: none"> ➤ Avoid constant, direct glances into the activated lights to prevent impairment of vision. <p>CAUTION - Risk of hearing impairment</p> <ul style="list-style-type: none"> ➤ Wear sound insulation equipment during work/testing to prevent hearing impairment.

Opening the housing

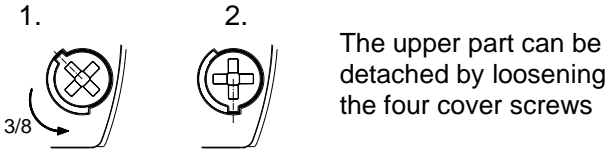

The upper part can be detached by loosening the four cover screws

Closing the housing

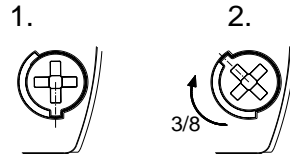

Close the housing by turning the cover screws to the end position until they lock in place.

The device is delivered in an unsealed condition.
Sealing plugs for the housing screws are available as accessories.

Cable feed-throughs

The supplied diaphragm nipple can be replaced by a cable gland or by an M12 plug-in connector with a flange dimension of M20.

- Only cable glands with a degree of protection of at least IP66 should be fitted to the corresponding openings.

Cable diameters of <7 mm require a cable gland with a sufficient degree of protection.

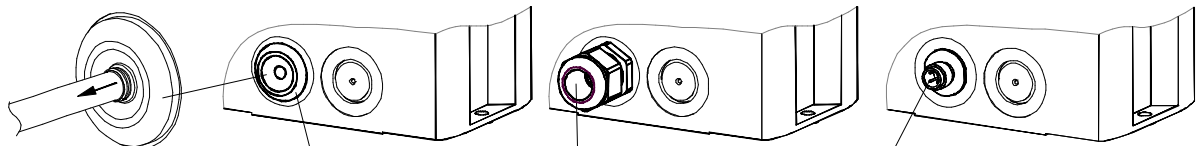

IP 66 only with the diaphragm funnel pointing outwards.

Diaphragm nipple IP 66 (supplied)

Cable gland IP 66 (option)

M12 plug-in connector IP 66, for low-voltage devices (option)

Remove the remains of the diaphragm after the cable has been fitted.

6.2 Electrical connection

➤ Observe the [Safety information!](#)

Circuit board in lower part:

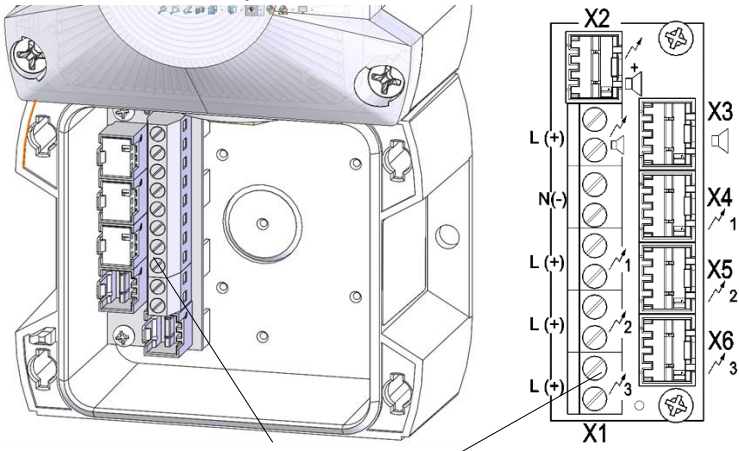

Connecting terminal (X1)

- X1** Operating voltage connection
- X2** Plug connection light for combined operation with sounder.
- X3** Plug connection sounder
- X4** Plug connection 1st stage
- X5** Plug connection 2nd stage
- X6** Plug connection 3rd stage

Connecting cables:

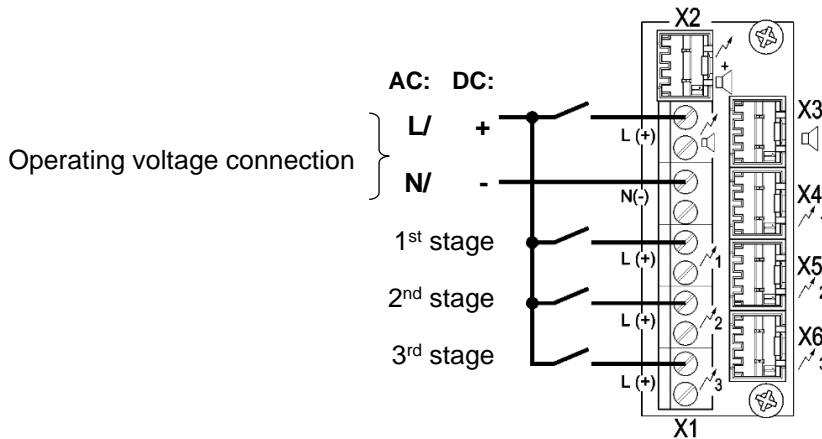

Note: Devices with DC voltage are equipped with reverse polarity protection. No function if the polarity of the connections is reversed.

6.3 Setting the operating modes

Circuit board in the lens:

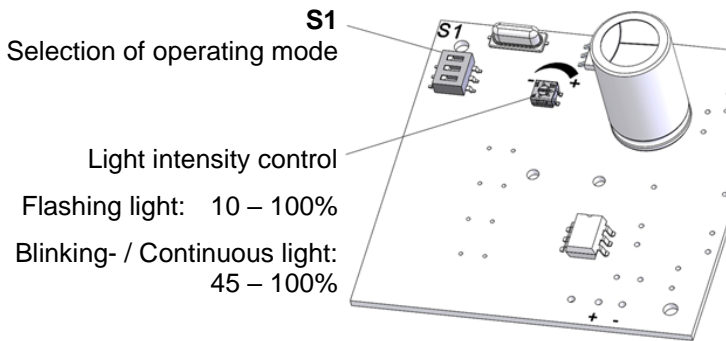

S1			Operating mode
1	2	3	
OFF	OFF	OFF	Flashing light 1 Hz *
OFF	OFF	ON	Flashing light 0.75 Hz
OFF	ON	OFF	Continuous light
OFF	ON	ON	Blinking light 1 Hz
ON	OFF	OFF	Flashing light 2 Hz
ON	OFF	ON	Blinking light 2 Hz
ON	ON	OFF	Flashing light 0.1 Hz
ON	ON	ON	Flashing light 0.5 Hz

* Factory setting

6.4 Tone settings (on the driver board in the upper part)

The desired tone can be selected using the tone selector switch **S3** (on the driver board in the upper part). The possible tones are described in the tone type table in the Annex. The tone is generated after the supply voltage is applied.

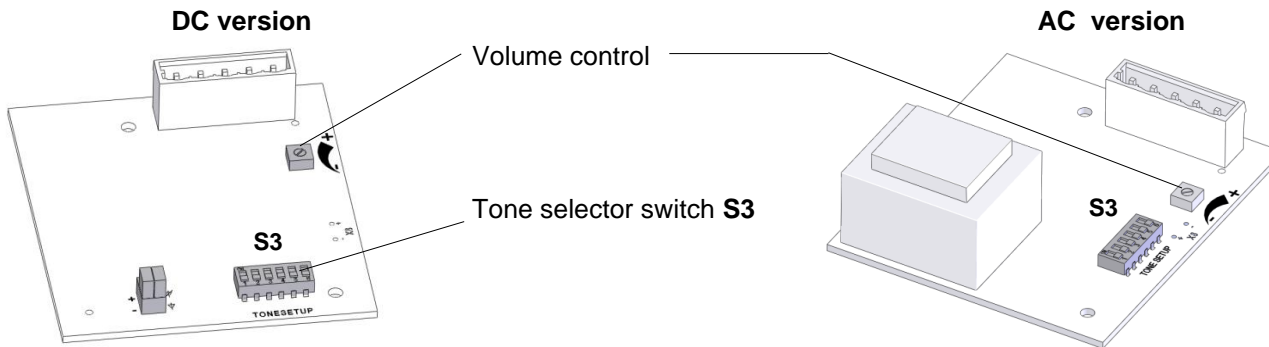

7. Accessories

Item No.	Designation
28300000002	Sealing plug, 4-pack
28912000000	Spare locking bolt, 4-pack

8. Maintenance, service, repairs

- Observe the [Safety information](#) during all work on the device.

The device requires no special maintenance.

- Carry out external cleaning using a weak soap solution without using any solvents.
- Only replace components using original spare parts.
- Only have repairs carried out at the manufacturer's premises.

Conversions, modifications, improper and impermissible use as well as failure to observe the notes in these operating instructions shall void any warranty.

9. Decommissioning, dismantling and disposal

- Observe the [Safety information](#) during all work on the device.
- Only properly qualified personnel should dispose of old devices in accordance with applicable environmental regulations. Old devices are also professionally disposed of by Pfannenberg. Delivery to one of our manufacturing facilities shall be free of charge.



Pfannenberg GmbH
 Werner-Witt-Straße 1 • D- 21035 Hamburg
 Tel.: +49/ (0)40/ 734 12-0
 Fax: +49/ (0)40/ 734 12-101
 service@pfannenberg.com
<http://www.pfannenberg.com>

Sommaire

1. Utilisation conforme	1
2. Contenu de la livraison	1
3.1 Variantes	2
3.2 Dimensions	2
4. Caractéristiques techniques	3
4.1 Généralités.....	3
4.2 Caractéristiques électriques PY L-S-TL.....	3
4.3 Caractéristiques électriques PY L-S-TLA (partie sirène).....	3
5. Admissions	4
6. Mise en service	4
6.1 Consignes de sécurité	4
6.2 Branchement électrique	6
6.3 Réglage des modes opératoires optiques	6
6.4 Réglages du son	7
7. Accessoires	7
8. Maintenance, entretien, réparation	7
9. Mise hors service, démontage et élimination	7

1. Utilisation conforme

Les feux de signalisation à DEL de la série PYRA sont conçus pour la signalisation des situations dangereuses dans l'industrie, le commerce et le secteur du bâtiment.

La DEL dans la partie feu peut fonctionner dans différents modes opératoires, réglables au moyen d'un commutateur interne.

Les versions PY-TLA avec module sirène intégré offrent également la possibilité d'une signalisation sonore avec 80 sons différents. Les sons peuvent être réglés à l'aide d'un commutateur interne situé dans la partie supérieure de la sirène.

Exploiter les appareils uniquement s'ils sont en bon état, dans les limites des caractéristiques spécifiées. Le fonctionnement de l'appareil n'est garanti que si les parties supérieure et inférieure ont été correctement assemblées.

Les appareils conviennent à une utilisation à l'intérieur comme à l'extérieur et sont uniquement destinés à une installation stationnaire.

2. Contenu de la livraison

La livraison se compose des éléments suivants :

- 1x appareil de signalisation (préassemblé)
- ou
- 1x partie inférieure PY L-S-TL (2, 3, 4 niveaux) + capots adaptés ou partie supérieure de la sirène
- 1x raccord fileté à membrane M20
(Option : presse-étoupe / fiche M12)
- 1x notice abrégée

3.1 Variantes

Préassemblées :
Avec séquence de couleurs standard

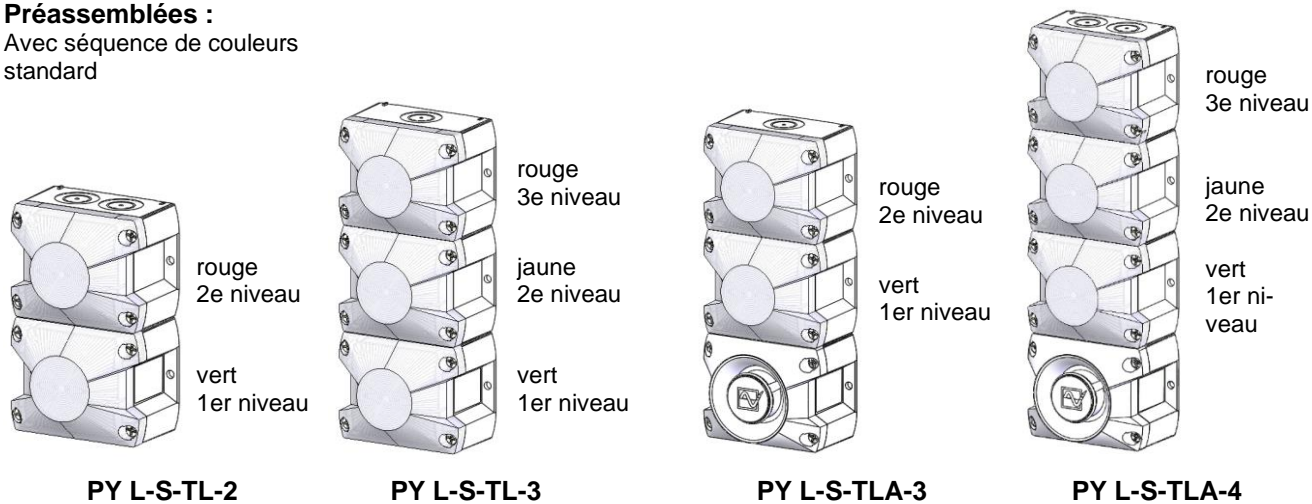

Libre choix des couleurs :
Exemple
PY L-S-TLA-4

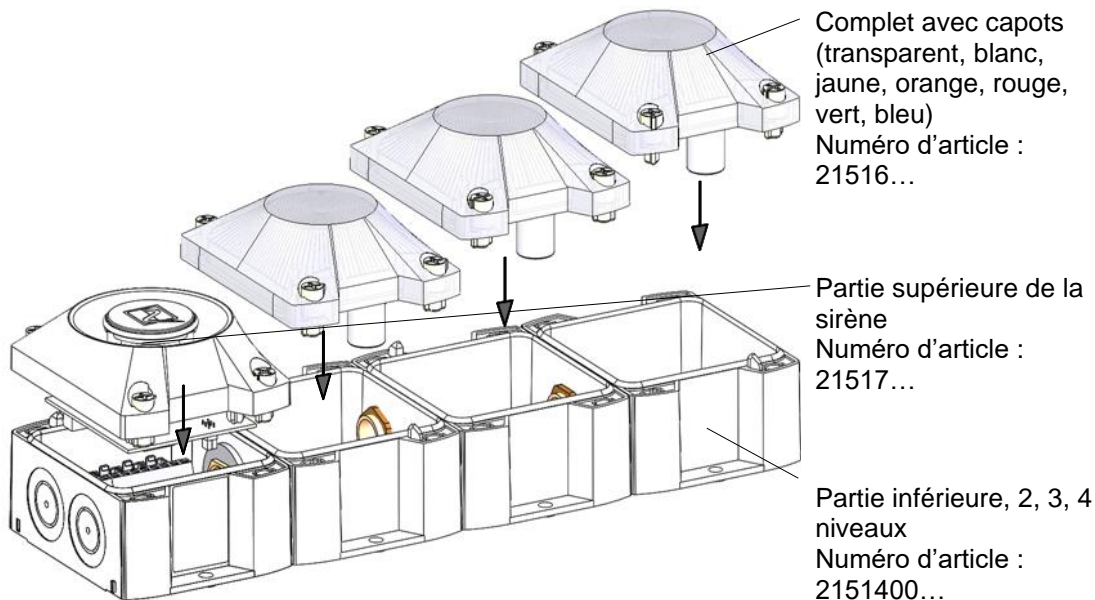

3.2 Dimensions

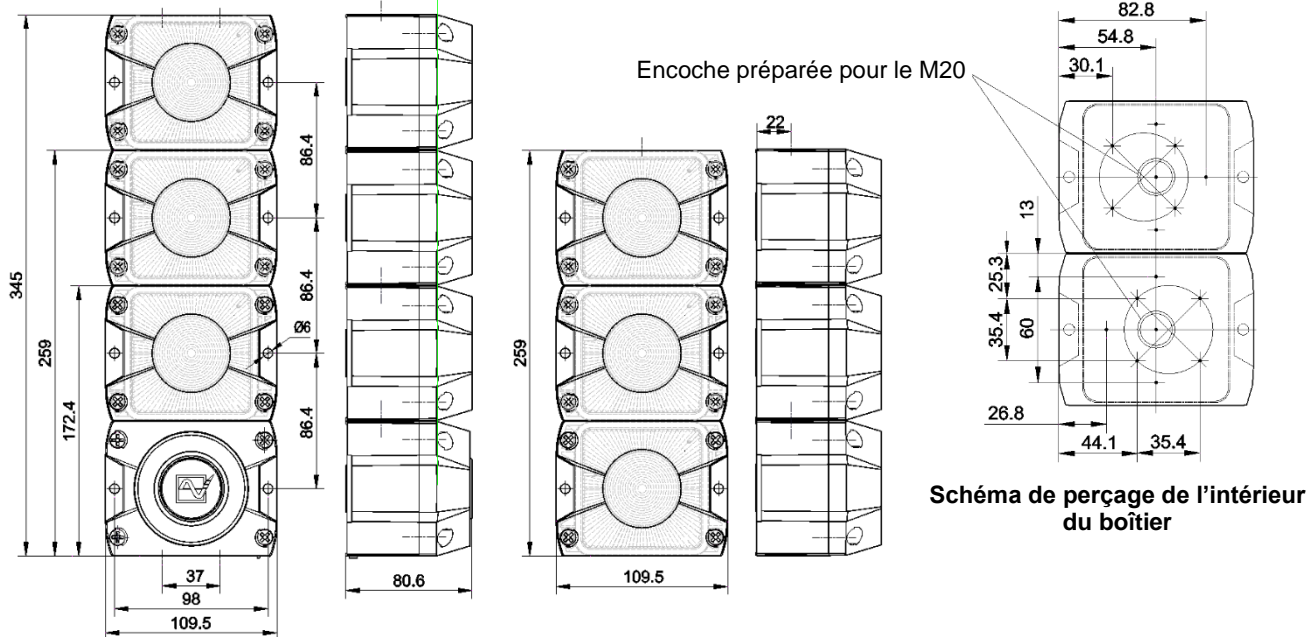

4. Caractéristiques techniques

4.1 Généralités

	PY L-S-TL	PY L-S-TLA
Niveau sonore maximal	--	105 dB (A) 1 m
Réglage du volume sonore	--	max. -12 dB
Sons	--	80
Intensité lumineuse	76 cd (clair)	
Source lumineuse	1x DEL haute puissance / niveau	
Facteur de marche	100 %	
Bornes	0,14 - 2,5 mm ² à fil fin / AWG24 - AWG 14	
Indice de protection	IP 66 (EN 60529), type 4 & 4x	
Résistance aux chocs	IK08 (EN 50102)	
Classe de protection	II	
Température de service	-40 °C... +55 °C	
Température de stockage	-40 °C... +70 °C	
Humidité relative max.	90 %	
Entrée de câble	4 niveaux : 8x M20 avec empreinte préalable 2 et 3 niveaux : 6x M20 avec empreinte préalable	
Zone d'étanchéité du passe-fil	7 – 13 mm	En cas d'utilisation de câbles de diamètre < 7 mm, prévoir un presse-étoupe d'un indice de protection suffisant
Matériau du boîtier	PC/ ABS Blend	
Matériau du capot	PC	
Position de montage	au choix	
Couleurs du capot	transparent, blanc, jaune, orange, rouge, vert, bleu	

4.2 Caractéristiques électriques PY L-S-TL

Plage de tensions assignées (pour les limites, voir Homologations)	12 V – 48 V CC			24 V CA 50/60 Hz	115 – 230 V CA, 50/60 Hz 120 V CC		
Plage de tensions de service	10 – 60 V CC			21,6 – 26,4 V CA	90 – 265 V CA 108 -132 V CC		
Consommation de courant assignée / niveau (max.)	12 V CC	24 V CC	48 V CC	167 mA	120 V CC	115 V CA	230 V CA
	275 mA	120 mA	65 mA		74,4 mA	51 mA	36 mA
Puissance absorbée / niveau (max.)	3,3 W	2,9 W	3,1 W	4 VA	2,93 W	5,9 VA	8,3 VA

4.3 Caractéristiques électriques PY L-S-TLA (partie sirène)

Plage de tensions assignées	12 V – 48 V CC	24 V CA 50/ 60 Hz	115 V CA 50/ 60 Hz	230V CA 50/ 60 Hz
Plage de tensions de service	10 – 57 V CC	21,6 – 26,4 V CA	95 – 127 V CA	195 – 253 V CA
Consommation de courant assignée (partie sirène) (max.)	24 V CC: 80 mA	150 mA	30 mA	16 mA
Puissance absorbée partie sirène (max.)	12 – 48 V: 4 W 24 V: 2W	4,5 VA	4,5 VA	4,5 VA





5. Admissions

(Les admissions sont valables pour les appareils marqués)

UL, cUL	E189090 UCST, UCST7, ULSZ, ULSZ7, UEES, UEES7 (pour plus d'informations, voir la page 4 de la partie en langue anglaise)
---------	--

6. Mise en service

6.1 Consignes de sécurité

	<p>DANGER - Danger de mort par décharge électrique</p> <p>Les appareils sous tension et les câbles de raccordement dénudés peuvent provoquer des décharges électriques et des accidents graves.</p> <ul style="list-style-type: none"> ➤ Les travaux sur les branchements électriques ne peuvent être effectués que par des professionnels agréés, formés en électrotechnique. ➤ Avant le montage, débrancher tous les câbles d'alimentation électrique et veiller à ce que le courant ne soit pas rétabli. S'assurer toujours de l'absence de tension. ➤ Attendre la fin de la phase de décharge de 5 minutes pour les composants électriques. L'appareil peut ensuite être ouvert. ➤ La tension de service ne doit être appliquée que lorsque le boîtier est solidement fermé.
	<p>AVERTISSEMENT - Risque lié à une utilisation non conforme des appareils</p> <p>Une utilisation non conforme peut entraîner des accidents graves.</p> <ul style="list-style-type: none"> ➤ Lors de l'installation, s'assurer que le câble de raccordement est protégé contre la traction et la torsion. Les appareils sont uniquement destinés à une installation stationnaire. ➤ Pour assurer un fonctionnement sur le long terme : ➤ Ne pas monter le pavillon orienté vers le haut dans les environnements poussiéreux ou à l'extérieur.
	<p>DANGER - Risque lié à la détérioration des appareils</p> <p>Le non-respect des indications de la plaque signalétique peut entraîner des accidents graves.</p> <ul style="list-style-type: none"> ➤ Lors de l'installation et de la maintenance des appareils, toujours tenir compte des indications figurant sur la plaque signalétique.
	<p>ATTENTION - Risque de blessures par des arêtes vives ou des composants chauds</p> <ul style="list-style-type: none"> ➤ Porter des gants lors des travaux d'installation, de montage ou d'entretien / de maintenance. ➤ Réaliser le câblage à l'écart des arêtes vives, des coins pointus et des composants internes.
	<p>ATTENTION – Risques d'altération de la vision</p> <ul style="list-style-type: none"> ➤ Pour prévenir toute altération de la vision, éviter de regarder en permanence et directement le feu activé. <p>ATTENTION - Risques d'altération de l'ouïe</p> <ul style="list-style-type: none"> ➤ Porter un équipement anti-bruit pour prévenir toute altération de l'ouïe pendant les travaux ou les tests.

Ouverture du boîtier

1.

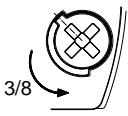

2.



La partie supérieure peut être retirée en desserrant les quatre vis du couvercle.

Fermeture du boîtier

1.



2.

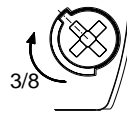

Pour refermer le boîtier, tourner les vis du couvercle jusqu'à la position finale de verrouillage.

À la livraison, l'appareil n'est pas verrouillé.

Des bouchons de plombage sont disponibles dans les accessoires pour les vis du boîtier.

Passage des câbles

Le raccord fileté à membrane fourni peut être remplacé par un presse-étoupe ou par un connecteur M12 avec une bride de dimension M20.

- Monter uniquement des presse-étoupes présentant un indice de protection supérieur ou égal à IP66 au niveau des perçages prévus à cet effet.

En cas d'utilisation de câbles de diamètre < 7 mm, prévoir un presse-étoupe d'un indice de protection suffisant.

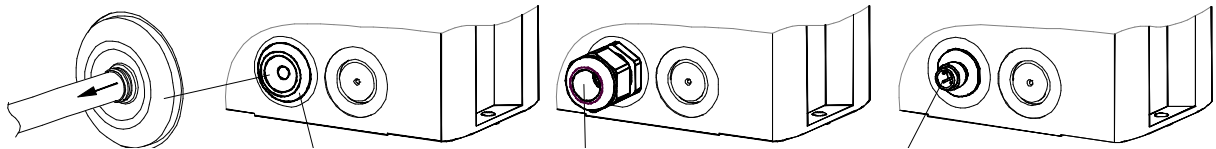

Protection IP 66 seulement lorsque le pavillon de la membrane est orienté vers l'extérieur.

Raccord fileté à membrane IP 66 (fourni)

Presse-étoupe IP 66 (Option)

Connecteur M12 IP 66, pour appareils à très basse tension (Option)

Après le montage du câble, enlever le reste de la membrane.

6.2 Branchement électrique

- Tenir compte des [Consignes de sécurité](#) !

Platine de raccordement dans la partie inférieure :

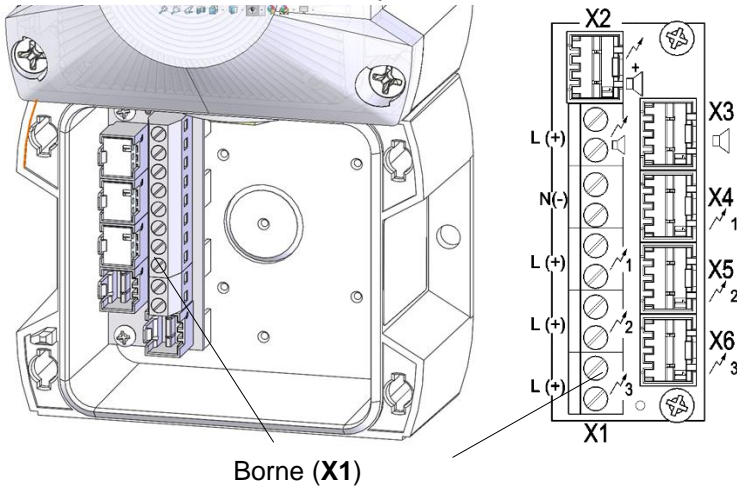

- X1** Raccordement de la tension de service
- X2** Fiche de la platine des feux pour un fonctionnement commun avec la sirène
- X3** Fiche de la platine de la sirène
- X4** Fiche de 1er niveau
- X5** Fiche de 2e niveau
- X6** Fiche de 3e niveau

Borne (X1)

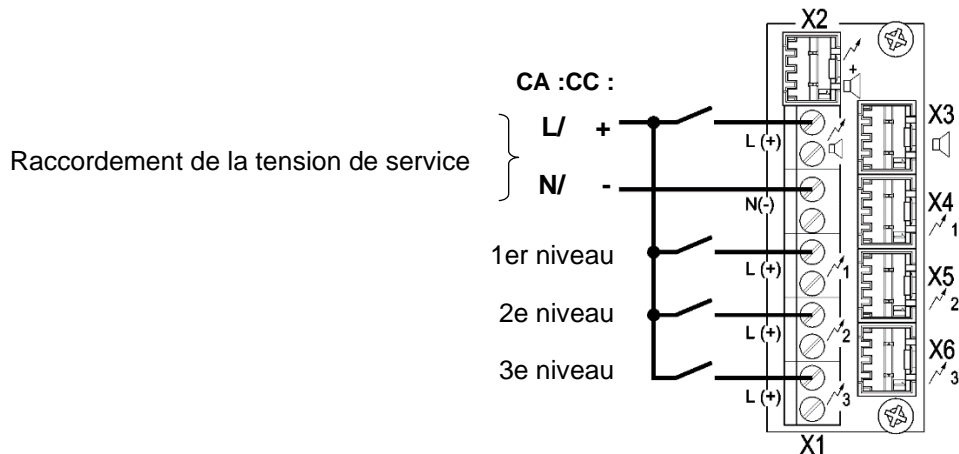

Remarque : les appareils à tension continue (CC) sont dotés d'une protection contre l'inversion de polarité. Le fonctionnement n'est pas garanti en cas d'inversion de la polarité des raccordements.

6.3 Réglage des modes opératoires optiques

Platine dans le capot :

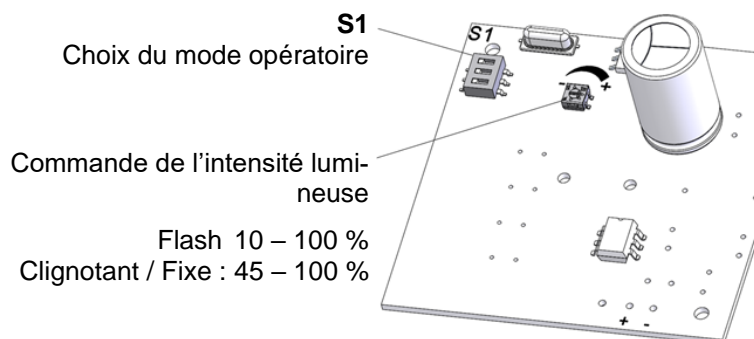

S1			Mode opératoire
1	2	3	
OFF	OFF	OFF	Flash 1 Hz *
OFF	OFF	ON	Flash 0,75 Hz
OFF	ON	OFF	Fixe
OFF	ON	ON	Clignotant 1 Hz
ON	OFF	OFF	Flash 2 Hz
ON	OFF	ON	Clignotant 2 Hz
ON	ON	OFF	Flash 0,1 Hz
ON	ON	ON	Flash 0,5 Hz

* Réglage d'usine

6.4 Réglages du son

Le son souhaité peut être sélectionné à l'aide du commutateur de tonalité **S3** sur la platine pilote dans la partie supérieure de la sirène. Les sons possibles sont décrits dans le tableau des sons en annexe. Après l'application de la tension d'alimentation, un son est émis.

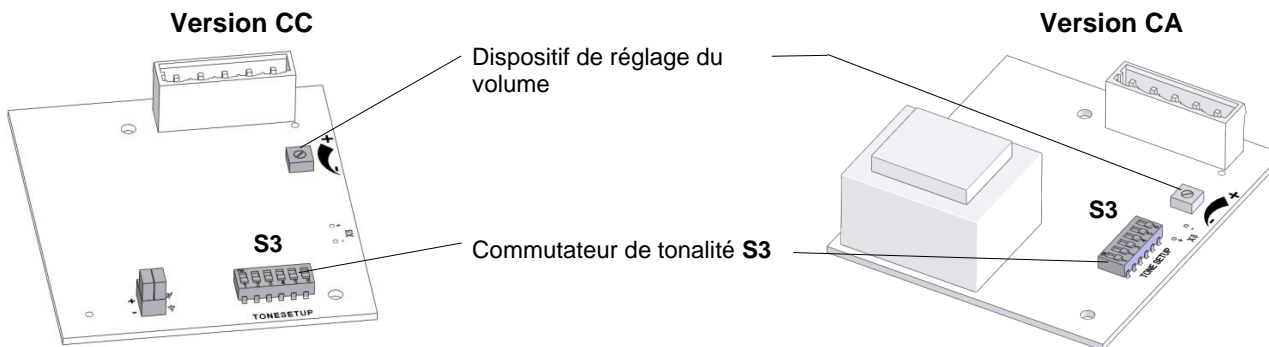

7. Accessoires

Numéro d'article	Description
28300000002	Bouchons de plombage, lot de 4
28912000000	Boulons de verrouillage de rechange, lot de 4

8. Maintenance, entretien, réparation

- Tenir compte des [Consignes de sécurité](#) pour toutes les interventions sur l'appareil.

L'appareil ne nécessite aucune maintenance particulière.

- Le nettoyage extérieur doit être effectué avec une solution légèrement savonneuse, sans solvant.
- Tous les composants doivent être uniquement remplacés par des pièces d'origine.
- Les réparations doivent en principe être effectuées dans les ateliers du fabricant.

Toute transformation, modification, utilisation incorrecte ou interdite ainsi que le non-respect des instructions de service entraînent une exclusion de garantie.

9. Mise hors service, démontage et élimination

- Tenir compte des [Consignes de sécurité](#) pour toutes les interventions sur l'appareil.
- Les appareils usagés doivent uniquement être éliminés par du personnel qualifié et conformément à la réglementation environnementale en vigueur.

Les appareils usagés sont également éliminés par Pfannenberg dans les règles de l'art. La livraison à l'une de nos usines de fabrication doit être gratuite.



Pfannenberg GmbH
 Werner-Witt-Straße 1 • D- 21035 Hamburg
 Tel.: +49/ (0)40/ 734 12-0
 Fax: +49/ (0)40/ 734 12-101
 service@pfannenberg.com
<http://www.pfannenberg.com>

Contenuto

1. Uso conforme	1
2. Scopo della fornitura	1
3.1 Varianti	2
3.2 Dimensioni	2
4. Dati tecnici	3
4.1 Caratteristiche generali	3
4.2 Dati elettrici PY L-S-TL	3
4.3 Dati elettrici PY L-S-TLA (segnalatore acustico)	3
5. Omologazioni	4
6. Messa in funzione	4
6.1 Istruzioni di sicurezza.....	4
6.2 Collegamento elettrico	6
6.3 Impostazione delle modalità operative visive	6
6.4 Toni	7
7. Accessori	7
8. Manutenzione, assistenza, riparazione	7
9. Messa fuori servizio, smontaggio e smaltimento	7

1. Uso conforme

Le luci semaforiche LED della serie PYRA sono indicate per la segnalazione degli stati di pericolo in ambienti industriali, commerciali e negli edifici.

Le luci LED consentono diverse modalità operative che è possibile impostare attraverso un interruttore interno. Le versioni PY-TLA con modulo di segnalazione acustica integrato offrono anche la possibilità di emettere segnali acustici con 80 toni diversi. Un interruttore interno posto sulla parte superiore con il segnalatore acustico consente di impostare i toni.

Utilizzare l'attrezzatura solo se non danneggiata e nel rispetto delle specifiche del cliente. Il funzionamento dell'attrezzatura è garantito solo se la parte superiore e quella inferiore sono montate in modo corretto. L'attrezzatura è adatta all'impiego all'aperto e in ambienti chiusi, ma solo per il montaggio fisso.

2. Scopo della fornitura

La fornitura comprende:

- N. 1 segnalatore acustico (preconfezionato)
oppure
- N. 1 parte inferiore PY L-S-TL (2, 3, 4 elementi) + calotte compatibili/parte superiore dei segnalatori acustici
- N.1 membrana M20
(opzione: pressacavo/connettore M12)
- N.1 guida rapida

3.1 Varianti

Preconfezionate
Con colori in successione
standard

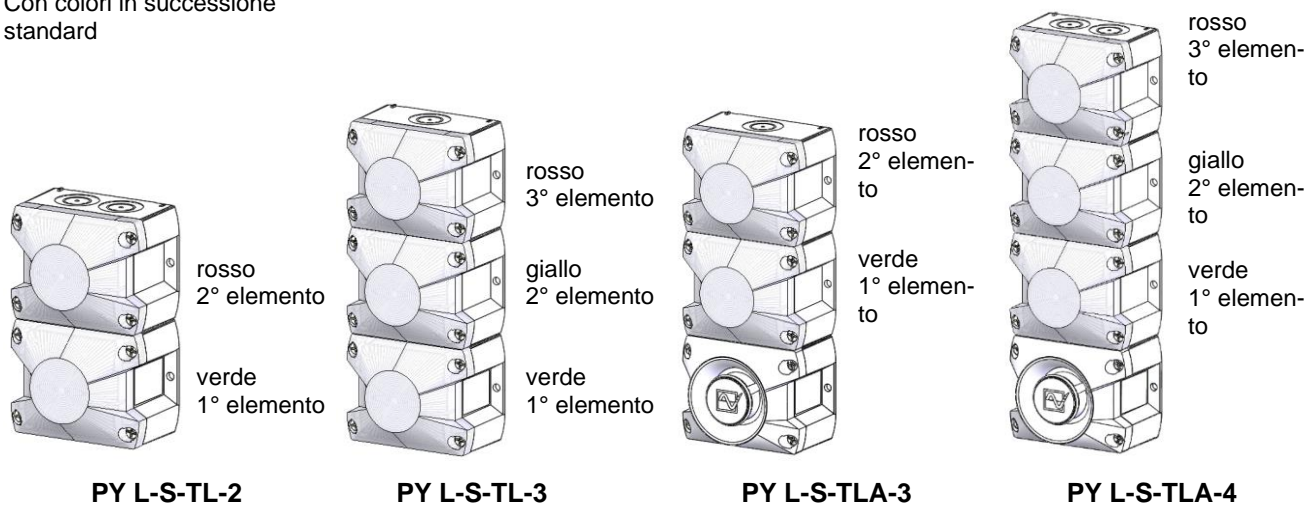

Colori a libera scelta

Esempio
PY L-S-TLA-4

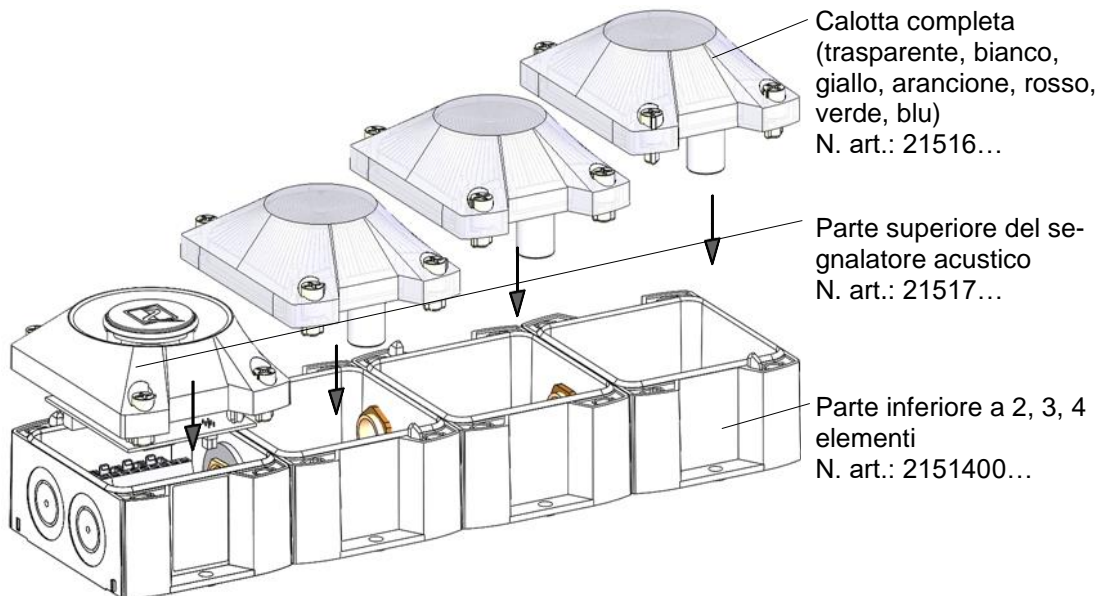

3.2 Dimensioni

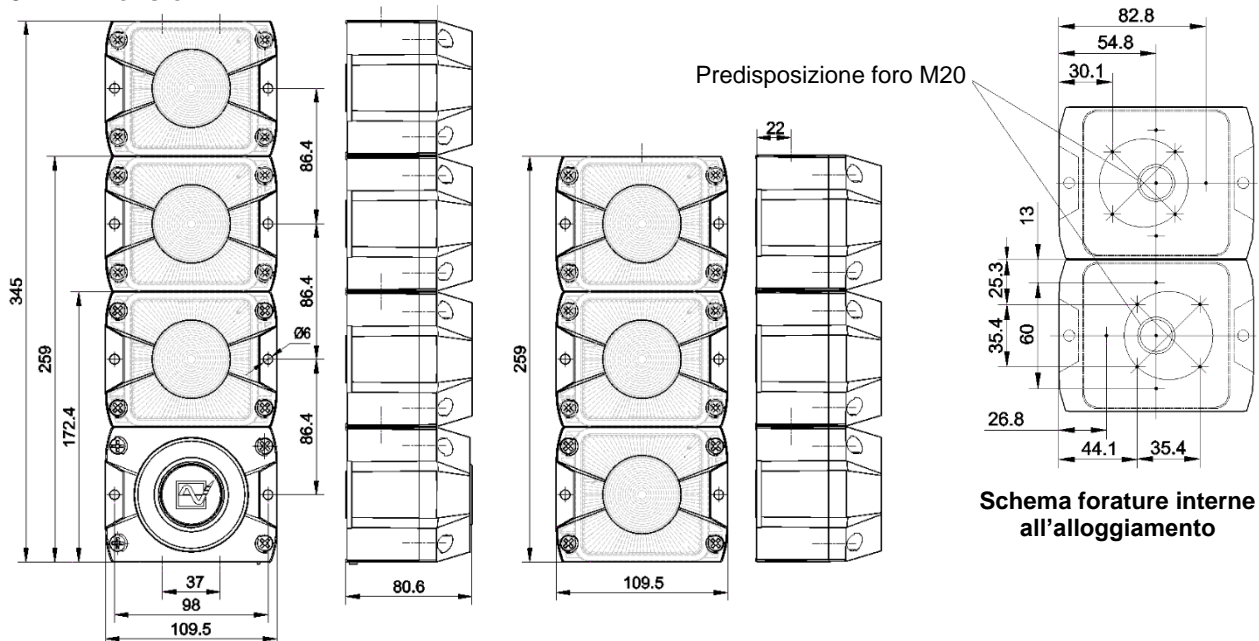

4. Dati tecnici

4.1 Caratteristiche generali

	PY L-S-TL	PY L-S-TLA
Pressione acustica max.	--	105 dB (A) 1m
Regolazione del volume	--	max. -12 dB
Toni	--	80
Intensità della luce	76 cd (trasparente)	
Fonte	N. 1 LED ad alte prestazioni/elemento	
Fattore di servizio	100%	
Terminali di collegamento	0,14 - 2,5mm ² filo sottile / AWG24 - AWG 14	
Modo di protezione	IP 66 (EN 60529), tipo 4 & 4x	
Resistenza agli urti	IK08 (EN 50102)	
Classe di protezione	II	
Temperatura d'esercizio	-40 °C...+55 °C	
Temperatura di stoccaggio	-40 °C...+70 °C	
Umidità rel. max.	90%	
Ingresso cavi	A quattro elementi: 8x M20 preforati A 2 e 3 elementi: 6x M20 preforati	
Area di tenuta degli occhiali	7 – 13 mm Se il diametro dei cavi è inferiore a 7 mm è necessario applicare un pressacavi con protezione adeguata.	
Materiale alloggiamento	PC/ ABS Blend	
Materiale calotta	PC	
Montaggio	A piacere	
Colori calotta	Trasparente, bianco, giallo, arancione, rosso, verde, blu	

4.2 Dati elettrici PY L-S-TL

Campo tensione nominale (per limitazioni v. omologazioni)	12 V – 48 V cc			24 V ca 50/ 60 Hz	115 – 230V ca, 50/ 60 Hz 120 V cc		
Campo tensione operativa	10 – 60 V cc			21,6 – 26,4 V ca	90 – 265 V ca 108 -132V cc		
Corrente nominale assorbita/elemento (max)	12 V cc	24 V cc	48 V cc	167 mA	120V cc	115 V ca	230 V ca
	275 mA	120 mA	65 mA		74,4 mA	51 mA	36 mA
Potenza assorbita /elemento (max)	3,3 W	2,9 W	3,1 W	4 VA	2,93 W	5,9 VA	8,3 VA

4.3 Dati elettrici PY L-S-TLA (segnalatore acustico)

Campo tensione nominale	12 V – 48 V cc	24 V ca 50/ 60 Hz	115 V ca 50/ 60 Hz	230V ca 50/ 60 Hz
Campo tensione operativa	10 – 57 V cc	21,6 – 26,4 V ca	95 – 127 V ca	195 – 253 V ca
Corrente nominale assorbita (segnalatore acustico) (max)	24 V DC: 80 mA	150 mA	30 mA	16 mA
Potenza assorbita (segnalatore acustico) (max)	12 – 48 V: 4 W 24 V: 2W	4,5 VA	4,5 VA	4,5 VA





5. Omologazioni

(Le omologazioni sono valide per le attrezzature indicate)

UL, cUL	E189090 UCST, UCST7, ULSZ, ULSZ7, UEES, UEES7 (per ulteriori informazioni fare riferimento alla pagina 4 del capitolo in inglese)
---------	---

6. Messa in funzione

6.1 Istruzioni di sicurezza

	<p>PERICOLO - Scosse elettriche letali Le parti sotto tensione e i cavi di collegamento liberi possono generare scosse elettriche causando gravi incidenti.</p> <ul style="list-style-type: none"> ➤ Solo personale autorizzato e con formazione in elettrotecnica è autorizzato a eseguire interventi sui collegamenti elettrici. ➤ Prima del montaggio togliere tensione a tutte le linee in ingresso e metterle in sicurezza in modo che non possano riattivarsi. Accertarsi sempre che non ci sia tensione. ➤ Attendere 5 minuti affinché i componenti elettrici siano privi di tensione. A quel punto sarà possibile aprire l'apparecchio. ➤ È possibile riattivare la tensione operativa solo con l'alloggiamento perfettamente chiuso.
	<p>AVVERTENZA - Pericolo per uso non conforme L'uso non conforme dell'apparecchio può causare gravi incidenti.</p> <ul style="list-style-type: none"> ➤ Durante l'installazione accertarsi che i cavi di collegamento non siano soggetti a trazione o torsione. L'apparecchio è progettato per installazioni fisse. <p>Per non compromettere la durata:</p> <ul style="list-style-type: none"> ➤ evitare il montaggio in ambienti polverosi o all'esterno con il megafono rivolto verso l'alto.
	<p>PERICOLO - Pericolo per danneggiamento dell'apparecchio L'inosservanza dei dati sulla targa del tipo può causare gravi incidenti.</p> <ul style="list-style-type: none"> ➤ Durante le operazioni di installazione e manutenzione dell'apparecchio rispettare sempre i dati riportati sulla targa del tipo.
	<p>ATTENZIONE - Pericolo di lesioni per bordi taglienti o parti calde</p> <ul style="list-style-type: none"> ➤ Eseguire le operazioni di installazione, montaggio, manutenzione o assistenza indossando i guanti. ➤ Eseguire i collegamenti lontano da bordi taglienti, spigoli o componenti interni.
	<p>ATTENZIONE - Compromissione delle capacità visive</p> <ul style="list-style-type: none"> ➤ Per non compromettere la vista, evitare di rivolgere lo sguardo direttamente alla luce continua attiva. <p>ATTENZIONE - Compromissione delle capacità uditive</p> <ul style="list-style-type: none"> ➤ Al fine di evitare una compromissione delle capacità uditive, indossare sempre un'adeguata protezione acustica nel corso delle operazioni/dei test.

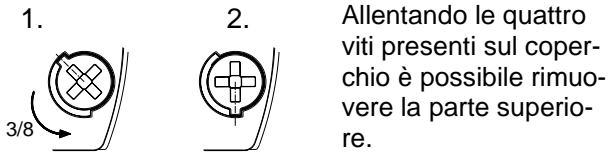
Apertura dell'alloggiamento

Allentando le quattro viti presenti sul coperchio è possibile rimuovere la parte superiore.

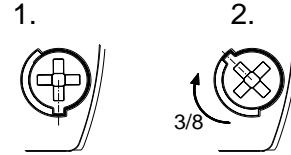
Chiusura dell'alloggiamento

Per chiudere l'alloggiamento, portare le viti del coperchio in posizione finale fino all'incastro.

L'attrezzatura non viene fornita chiusa.

I sigilli di garanzia per le viti dell'alloggiamento sono disponibili come accessorio.

Ingressi dei cavi

La membrana compresa nella fornitura può essere sostituita da un pressacavo o da un connettore M12 con flangia M20.

➤ Montare solo pressacavi con protezione minima IP66 e nelle apposite aperture.

Se il diametro del cavo è inferiore a 7 mm, usare un pressacavo con protezione adeguata.

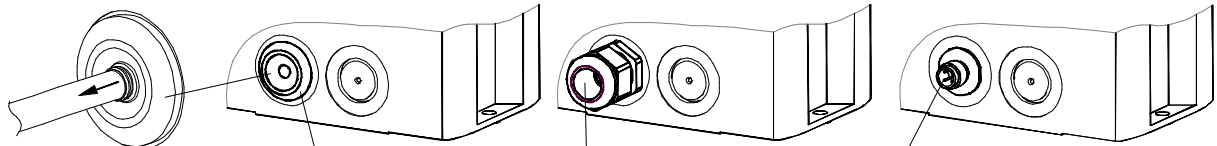

IP66 solo se la parte a imbuto della membrana è rivolta verso l'esterno.

Membrana IP66 (compresa)

Pressacavo IP 66 (opzione)

Connettore M12 IP66, per attrezzature a bassissima tensione (opzione)

Dopo aver montato il cavo, togliere i residui della membrana.

6.2 Collegamento elettrico

- Rispettare le [Istruzioni di sicurezza!](#)

Scheda di collegamento nella parte inferiore:

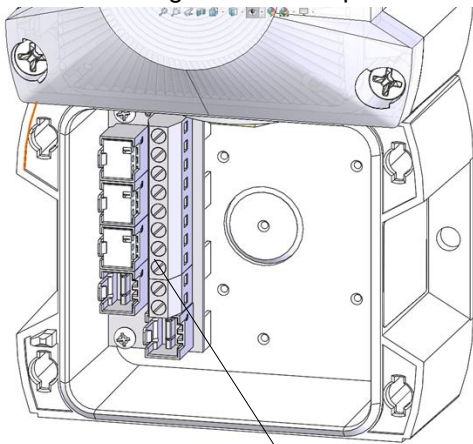

Terminale di collegamento (X1)

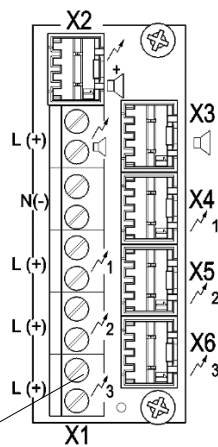

- X1** Collegamento tensione operativa
- X2** Connettore scheda luci per uso congiunto con segnalatore acustico
- X3** Connettore per segnalatore acustico
- X4** Connettore 1° elemento
- X5** Connettore 2° elemento
- X6** Connettore 3° elemento

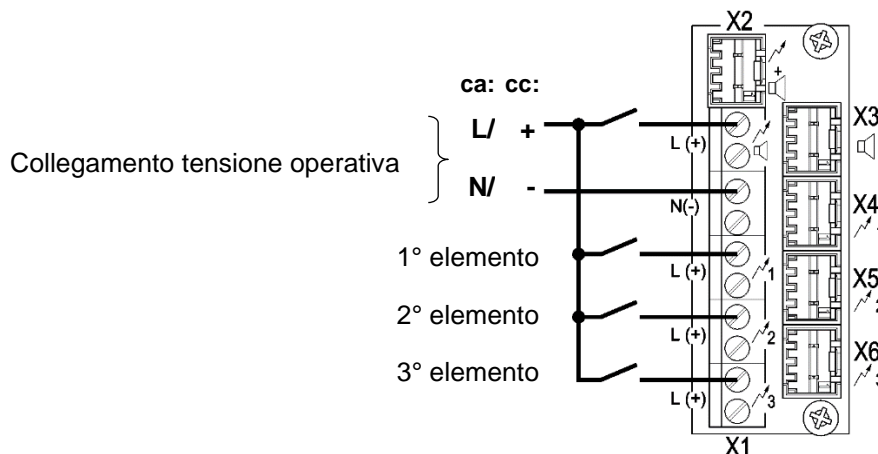

Nota: gli apparecchi in cc sono dotati di protezione da inversione di polarità. Se la polarità è invertita, l'apparecchio non funziona.

6.3 Impostazione delle modalità operative visive

Scheda nella calotta:

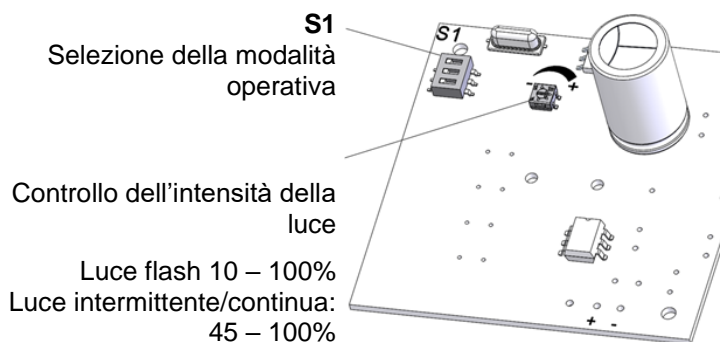

S1			Modalità operativa
1	2	3	
OFF	OFF	OFF	Luce flash 1 Hz *
OFF	OFF	ON	Luce flash 0,75 Hz
OFF	ON	OFF	Luce continua
OFF	ON	ON	Luce intermittente 1 Hz
ON	OFF	OFF	Luce flash 2 Hz
ON	OFF	ON	Luce intermittente 2 Hz
ON	ON	OFF	Luce flash 0,1 Hz
ON	ON	ON	Luce flash 0,5 Hz

* Impostazione di fabbrica

6.4 Toni

È possibile selezionare il tono desiderato mediante l'apposito interruttore **S3** sulla scheda di controllo nella parte superiore del segnalatore acustico. I possibili toni sono descritti nella tabella allegata. Il tono viene emesso una volta attivata la tensione di alimentazione.

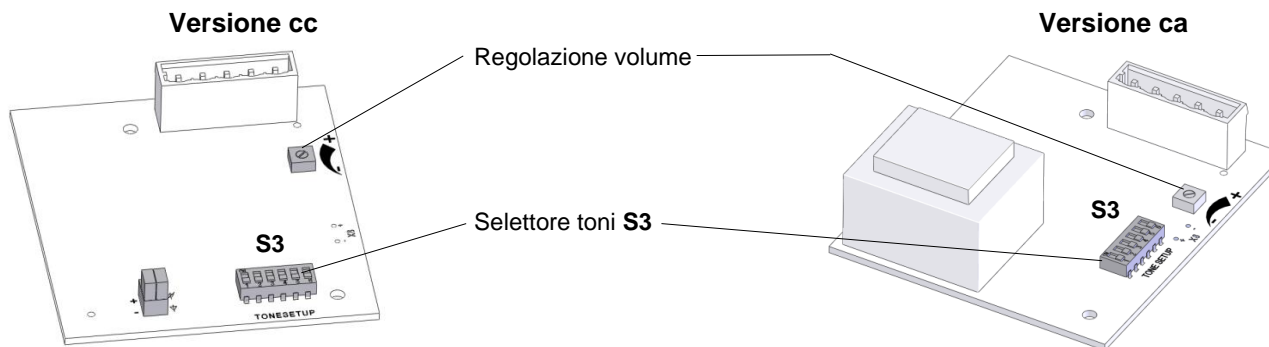

7. Accessori

N. art.	Descrizione
28300000002	Sigilli di garanzia, confezione da 4
28912000000	Perni di blocco di ricambio, confezione da 4

8. Manutenzione, assistenza, riparazione

- Quando si eseguono interventi sull'apparecchio rispettare le [Istruzioni di sicurezza](#).

L'apparecchio non richiede una particolare manutenzione.

- Pulire le parti esterne con una soluzione detergente delicata senza usare solventi.
- Sostituire i componenti con ricambi originali.
- Fare eseguire le riparazioni solo presso il fabbricante.

Interventi, modifiche, usi errati e non consentiti insieme al mancato rispetto delle istruzioni contenute nel presente manuale d'uso rendono nulla la garanzia.

9. Messa fuori servizio, smontaggio e smaltimento

- Quando si eseguono interventi sull'apparecchio rispettare le [Istruzioni di sicurezza](#).
- Lo smaltimento dei vecchi apparecchi deve essere eseguito da personale esperto e nel rispetto delle normative ambientali vigenti.

Lo smaltimento dei vecchi apparecchi può anche essere affidato a Pfannenberg. La consegna a uno dei nostri stabilimenti è gratuita.



Pfannenberg GmbH

Werner-Witt-Straße 1 • D- 21035 Hamburg

Tel.: +49/ (0)40/ 734 12-0

Fax: +49/ (0)40/ 734 12-101

service@pfannenberg.com

<http://www.pfannenberg.com>

Содержание

1. Применение по назначению	1
2. Объем поставки	1
3.1 Варианты	2
3.2 Размеры	2
4. Технические характеристики	3
4.1 Общая информация	3
4.2 Электрические параметры PY L-S-TL	3
4.3 Электрические параметры PY L-S-TLA	4
5. Разрешения	4
6. Ввод в эксплуатацию	4
6.1 Указания по технике безопасности	4
6.2 Подключение к электросети	6
6.3 Настройка оптических режимов работы	6
6.4 Настройки звукового тона	7
7. Дополнительные принадлежности	7
8. Уход, сервис, техническое обслуживание	7
9. Вывод из эксплуатации, демонтаж и утилизация	7

1. Применение по назначению

Светодиодные световые устройства серии PYRA предназначены для сигнализации, например, опасных состояний в промышленности, торговле и строительстве.

СИД в лампе может эксплуатироваться в различных режимах работы, которые можно настроить с помощью внутреннего переключателя.

Версии PY-TLA со встроенным модулем излучателя звука предоставляют дополнительную возможность акустической сигнализации 80 различных звуковых тонов. Звуковые тоны можно настраивать с помощью внутреннего переключателя в верхней части излучателя звука.

Эксплуатировать устройства только в неповрежденном состоянии в пределах указанных параметров. Функционирование устройства гарантируется только при правильной сборке верхней и нижней частей. Устройства предусмотрены для применения внутри и вне помещений и предназначены только для стационарного монтажа.

2. Объем поставки

Объем поставки состоит из:

- 1x сигнальное устройство (предварительно смонтированное)
или
- 1x нижняя часть PY L-S-TL (2-, 3-, 4-ступенчатая) + соответствующие колпаки или верхние части излучателя звука
- 1x мембранный ниппель M20
(Опция: кабельный ввод/ штекер M12)
- 1x краткое руководство

3.1 Варианты

Предварительно смонтировано:
Со стандартной последовательностью цветов

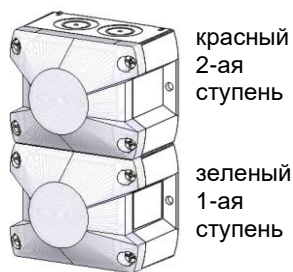

PY L-S-TL-2

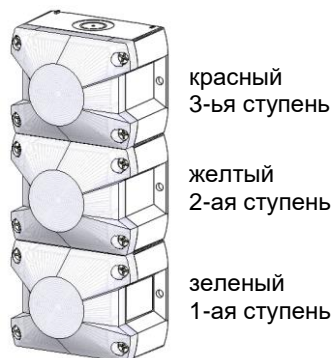

PY L-S-TL-3

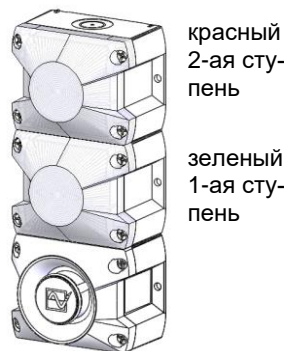

PY L-S-TLA-3



PY L-S-TLA-4

Свободный выбор цветов

Пример
PY L-S-TLA-4

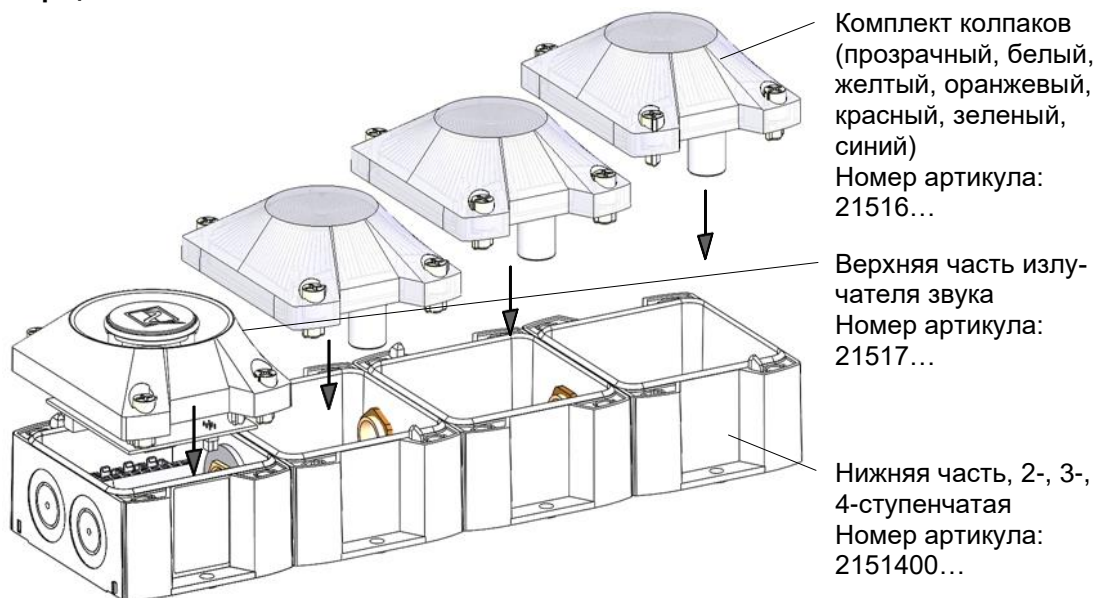

Комплект колпаков (прозрачный, белый, желтый, оранжевый, красный, зеленый, синий)
Номер артикула: 21516...

Верхняя часть излучателя звука
Номер артикула: 21517...

Нижняя часть, 2-, 3-, 4-ступенчатая
Номер артикула: 2151400...

3.2 Размеры

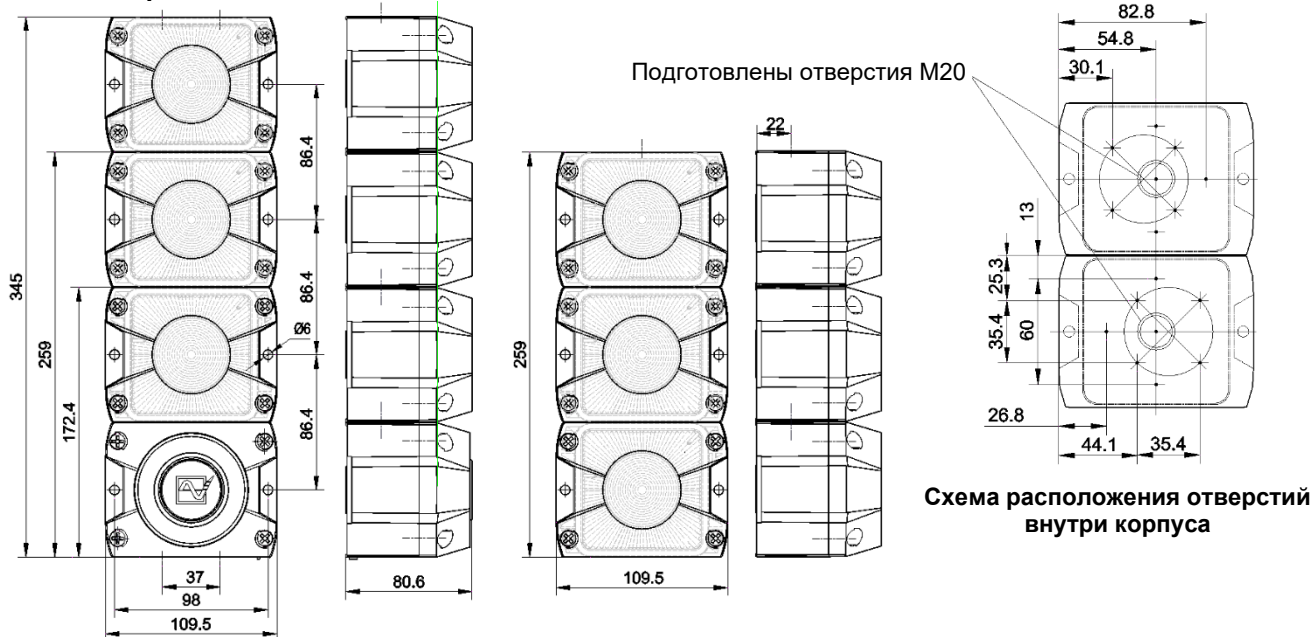

4. Технические характеристики

4.1 Общая информация

	PY L-S-TL	PY L-S-TLA
Макс. уровень звука	--	105 дБ (А) 1 м
Регулировка громкости	--	макс. -12 дБ
Звуковые тоны	--	80
Сила света	76 кд (прозрачный)	
Источник света	1х мощный СИД ступень/ ступень	
Продолжительность включения	100 %	
Соединительные зажимы	0,14 - 2,5 мм ² тонкопроволочные / AWG24 - AWG 14	
Род защиты	IP 66 (EN 60529), тип 4 и 4х	
Ударная прочность	IK08 (EN 50102)	
Класс защиты	II	
Рабочая температура	-40 °С...+55 °С	
Температура хранения	-40 °С...+70 °С	
Макс. отн. влажность воздуха	90 %	
Кабельный ввод	4-ступенчатый: 8х M20 выполнены 2- и 3-ступенчатый: 6х M20 выполнены	
Зона уплотнения проходной втулки	7 – 13 мм При использовании кабелей диаметром < 7 мм предусмотреть кабельный ввод с достаточной степенью защиты	
Материал корпуса	сплав полимеров PC/ ABS	
Материал колпака	PC	
Монтажное положение	любое	
Цвета колпака	прозрачный, белый, желтый, оранжевый, красный, зеленый, синий	

4.2 Электрические параметры PY L-S-TL

Диапазон номинального напряжения (ограничения смотри разрешения)	12 В – 48 В пост. тока			24 В перем. тока 50/ 60 Гц	115 – 230 В перем. Тока, 50/ 60 Гц 120 В пост. тока		
Диапазон рабочего напряжения	10 – 60 В пост. тока			21,6 – 26,4 В перем. тока	90 – 265 В перем. Тока 108 - 132 В пост. тока		
Номинальный потребляемый ток лампы / ступень (макс.)	12 В пост. тока	24 В пост. тока	48 В пост. тока	167 мА	120 В пост. тока	115 В перем. тока	230 В перем. тока
	275 мА	120 мА	65 мА		74,4 мА	51 мА	36 мА
Потребляемая мощность / ступень (макс.)	3,3 Вт	2,9 Вт	3,1 Вт	4 ВА	2,93 ВА	5,9 ВА	8,3 ВА

4.3 Электрические параметры PY L-S-TLA

Диапазон номинального	12 V – 48 V пост. Тока	24 V перем. тока 50/ 60 Hz	115 V перем. тока 50/ 60 Hz	230V перем. тока 50/ 60 Hz
Диапазон рабочего напряжения	10 – 57 V пост. тока	21,6 – 26,4 V перем. тока	95 – 127 V перем. тока	195 – 253 V перем. тока
Номинальный потребляемый ток (макс.)	24 V пост. тока: 80 mA	150 mA	30 mA	16 mA
Потребляемая мощность излу- чателя звука (макс.)	12 – 48 V: 4 Вт 24 V: Вт	4,5 ВА	4,5 ВА	4,5 ВА





5. Разрешения

(Разрешения действительны для отмеченных устройств)

UL, cUL	E189090 UCST, UCST7, ULSZ, ULSZ7, UEES, UEES7 (в отношении более подробную информацию см. страницу 4 в англоязычной главе)
---------	--

6. Ввод в эксплуатацию

6.1 Указания по технике безопасности

	<p>ОПАСНОСТЬ - Опасность для жизни в результате поражения электрическим током Находящиеся под напряжением устройства и открытые соединительные линии создают опасность поражения электрическим током и могут вызывать тяжелые несчастные случаи.</p> <ul style="list-style-type: none"> ➤ Работы над подключениями к электросети разрешается выполнять только обученным и авторизованным специалистам-электрикам. ➤ Перед монтажом все подводящие линии необходимо обесточить и заблокировать от повторного включения. Необходимо всегда удостоверяться в отсутствии напряжения. ➤ Выждать фазу разряда электрических компонентов длительностью в 5 минут. Лишь затем открывать устройство. ➤ Включение рабочего напряжения должно производиться только при плотно закрытом корпусе.
	<p>ПРЕДУПРЕЖДЕНИЕ - Опасность в результате недопустимого применения устройств Применение не по назначению может привести к тяжелым авариям.</p> <ul style="list-style-type: none"> ➤ Во время монтажа следить за тем, чтобы соединительный кабель был защищен от растяжения и перекручивания. Устройства предназначены исключительно для стационарного монтажа. <p>Для обеспечения длительного функционирования:</p> <ul style="list-style-type: none"> ➤ не устанавливайте рупор в пыльном окружении или на открытом месте направленным вверх.
	<p>ОПАСНОСТЬ - Опасность в результате повреждения устройств Несоблюдение данных заводской таблички может привести к тяжелым авариям.</p> <ul style="list-style-type: none"> ➤ При установке и техническом обслуживании устройств всегда учитывать данные на заводской табличке.
	<p>ВНИМАНИЕ - Опасность травмирования острыми кромками или горячими деталями</p> <ul style="list-style-type: none"> ➤ Во время работ по установке, монтажу или техническому обслуживанию носить перчатки. ➤ Разводку кабелей выполнять вдали от острых кромок, углов и внутренних компонентов.
	<p>ВНИМАНИЕ – Опасность ухудшения зрения</p> <ul style="list-style-type: none"> ➤ Чтобы не допустить ухудшения зрения, избегать длительного прямого зрительного контакта с включенной лампой. <p>ВНИМАНИЕ - Опасность ухудшения слуха</p> <ul style="list-style-type: none"> ➤ Чтобы предотвратить ухудшение слуха, используйте средства защиты от шума во время работы / тестирования.

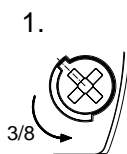
Открытие корпуса

Ослабив четыре винта крышки, можно снять верхнюю часть

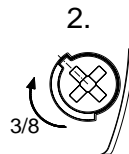
Закрытие корпуса

Закрыть корпус, повернув винты крышки до конечного положения, пока они не зафиксированы.

Устройство поставляется в незакрытом состоянии.

Заглушки для пломбирования винтов корпуса можно приобрести в виде дополнительного оборудования.

Кабельные вводы

Входящий в комплект поставки мембранный ниппель можно заменить кабельным вводом или штекерным соединителем M12 с размером фланца M20.

- Монтировать только кабельные вводы со степенью защиты минимум IP66 в соответствующих отверстиях.

В случае кабелей диаметром < 7 мм использовать кабельный ввод с достаточной степенью защиты.

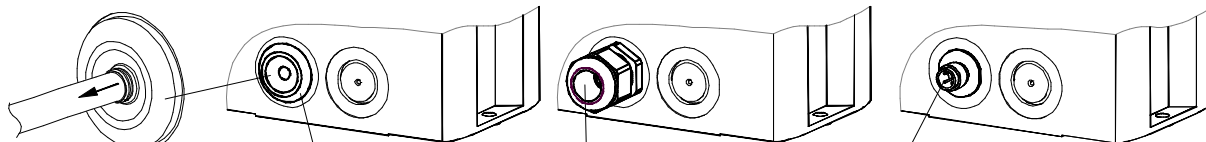

IP 66 только с воронкой мембраны, обращенной наружу. После монтажа кабеля удалить остатки мембраны.

Мембранный ниппель IP 66 (входит в комплект поставки)

Кабельный ввод IP 66 (Опция)

Штекерный соединитель M12 IP 66, для низковольтных устройств (Опция)

6.2 Подключение к электросети

➤ Соблюдать **Указания по технике безопасности!**

Панель подключения в нижней части:

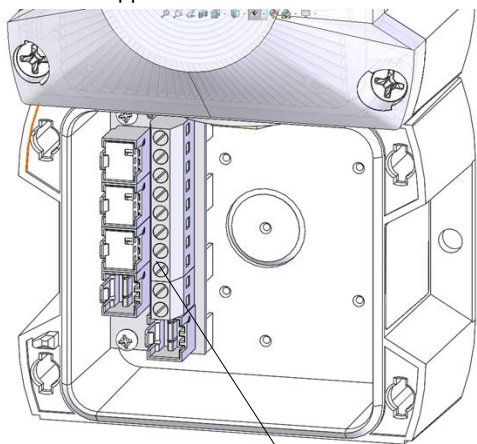

Соединительный зажим (X1)

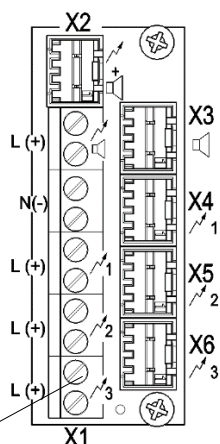

- X1** Подключение рабочего напряжения
- X2** Штекер платы лампы при совместной работе с 1-ой ступенью
- X3** Штекер платы излучателя звука
- X4** Штекер 1-ой ступени
- X5** Штекер 2-ой ступени
- X6** Штекер 3-ей ступени

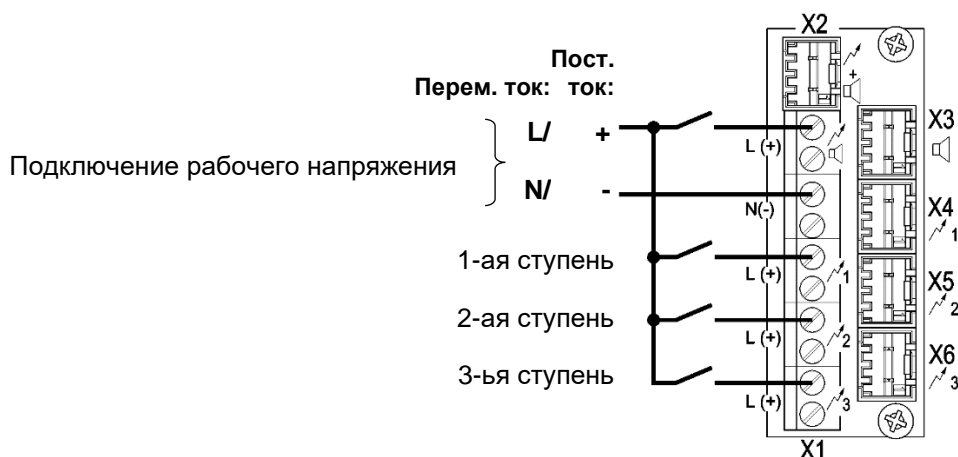

Указание: Устройства, работающие от напряжения пост. тока, оснащены защитой против инверсии полярности. При инверсии полярности подключения функционирования нет.

6.3 Настройка оптических режимов работы

Плата в колпаке:

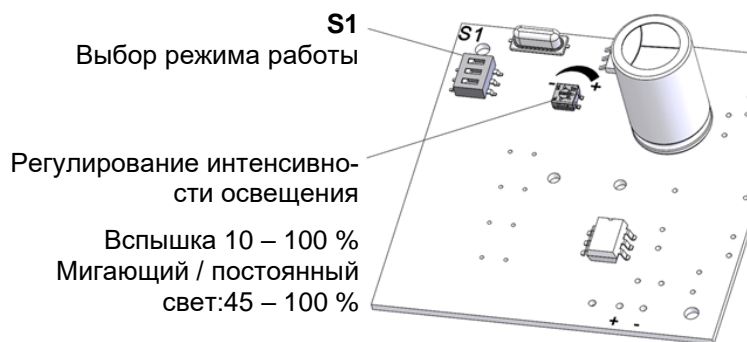

Вспышка 10 – 100 %
Мигающий / постоянный свет: 45 – 100 %

S1			Режим работы
1	2	3	
ВЫКЛ.	ВЫКЛ.	ВЫКЛ.	Вспышка 1 Гц *
ВЫКЛ.	ВЫКЛ.	ВКЛ.	Вспышка 0,75 Гц
ВЫКЛ.	ВКЛ.	ВЫКЛ.	Постоянный свет
ВЫКЛ.	ВКЛ.	ВКЛ.	Мигающий свет 1 Гц
ВКЛ.	ВЫКЛ.	ВЫКЛ.	Вспышка 2 Гц
ВКЛ.	ВЫКЛ.	ВКЛ.	Мигающий свет 2 Гц
ВКЛ.	ВКЛ.	ВЫКЛ.	Вспышка 0,1 Гц
ВКЛ.	ВКЛ.	ВКЛ.	Вспышка 0,5 Гц

* Заводская установка

6.4 Настройки звукового тона

Требуемый звуковой тон выбирается с помощью переключателя звуковых тонов **S3** на плате драйвера в верхней части излучателя звука. Возможные звуковые тоны описаны в таблице звуковых тонов в приложении.

После подачи напряжения питания генерируется звуковой тон.

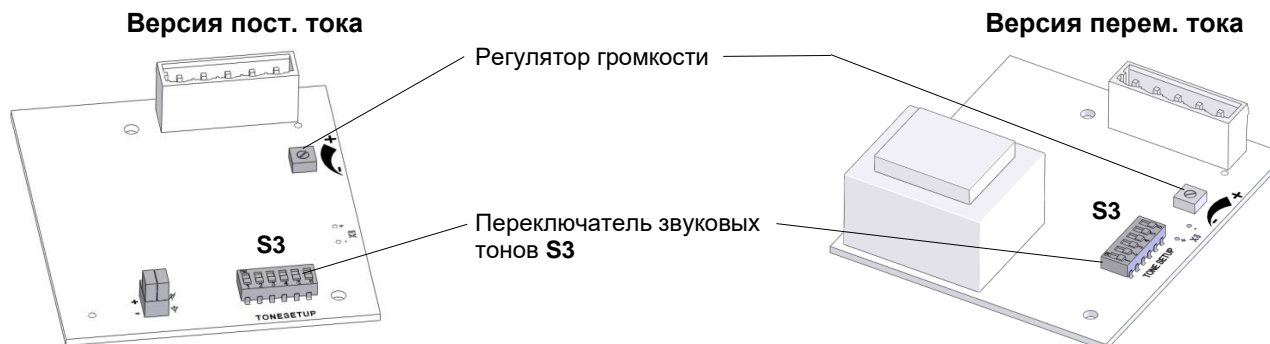

7. Дополнительные принадлежности

Номер артикула	Обозначение
28300000002	Заглушка для пломбирования, упаковка 4 шт.
28912000000	Запасной фиксатор, упаковка 4 шт.

8. Уход, сервис, техническое обслуживание

- При выполнении любых работ на устройстве соблюдать [Указания по технике безопасности](#).

Устройство не требует специального обслуживания.

- Выполнять наружную очистку слабым мыльным раствором без использования растворителей.
- Замена компонентов только на оригинальные запасные части.
- Выполнение ремонта принципиально поручать проводить только на заводе-изготовителе.

Модификации, изменения, неправильное и недопустимое использование, а также несоблюдение указаний, приведенных в данном руководстве по эксплуатации, исключают гарантию.

9. Вывод из эксплуатации, демонтаж и утилизация

- При выполнении любых работ на устройстве соблюдать [Указания по технике безопасности](#).
- Отслужившие свой срок устройства разрешается утилизировать только компетентным специалистам и в соответствии с действующими предписаниями по охране окружающей среды.











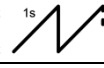
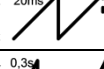
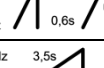

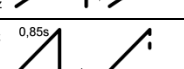
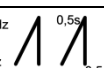
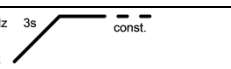
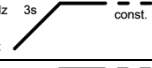
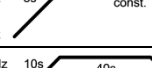
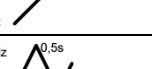
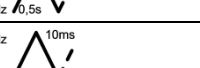

Отслужившие свой срок устройства надлежащим образом утилизирует также фирма Pfannenberg. Доставка на один из наших заводов должна осуществляться безвозмездно.











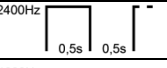
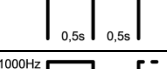

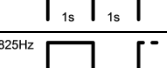

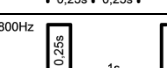
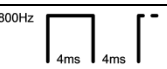
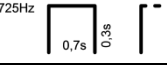
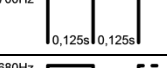
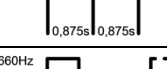
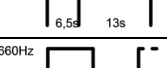
Pfannenberg GmbH
 Werner-Witt-Straße 1 • D- 21035 Hamburg
 Tel.: +49/ (0)40/ 734 12-0
 Fax: +49/ (0)40/ 734 12-101
 service@pfannenberg.com
<http://www.pfannenberg.com>

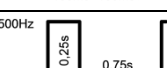
Anhang/ Appendix/ Annexe/ Appendice/ Приложение

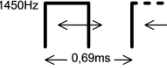
Tonartentabelle/ Tone table/ Tableau de sons/ Tabella suoni/ „Таблица звуковых тонов“

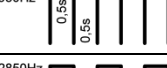
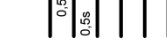
Grund-Ton-Nr. (♫)	Beschreibung/ Description/ Descrizione/ Описание	
1	Kein Ton/ Silence/ Pas de son/ Nessun suono	
2*	Saw tooth, Germany DIN 33404-3 (emergency signal), PFEER PTAP	1200Hz 500Hz 
9	Slow whoop, fire alarm, UK BS5839-1	970Hz 1s 800Hz 
11	Whoop (fast)	970Hz 20ms 800Hz 
13	Whoop	900Hz 0,3s 700Hz 0,6s 
15	Slow whoop, evacuation, Netherlands NEN 2575	1200Hz 3,5s 500Hz 0,5s 
16	Slow whoop, evacuation Australia AS2220	1200Hz 3,75s 500Hz 0,25s 
18	Slow whoop, NFPA	775Hz 0,85s 422Hz 1s 
22	Whoop, Australia AS1670, ISO8201	1200Hz 0,5s 500Hz 0,5s 1,5s 
23	Siren	2400Hz 3s 500Hz const. 
24	Siren	1200Hz 3s 300Hz const. 
25	Siren	800Hz 3s 300Hz const. 
26	Industrial alarm (Germany)	1000Hz 10s 150Hz 40s 10s 
27	Sweeping	2900Hz 0,5s 2400Hz 0,5s 
29	Sweeping (fast)	2900Hz 10ms 2400Hz 10ms 
30	Sweeping	2900Hz 70ms 2400Hz 70ms 
31	Sweeping, France NF C 48-265	1600Hz 1s 1400Hz 0,5s 
33	Sweeping, UK BS5839-1 (medium sweep)	1000Hz 0,5s 800Hz 0,5s 
34	Sweeping (fast)	1000Hz 10ms 800Hz 10ms 
35	Sweeping, UK BS5839-1 (fast sweep)	1000Hz 70ms 800Hz 70ms 
36	Sweeping	1500Hz 1,5s 700Hz 1,5s 
43	Sweeping	1200Hz 1,5s 500Hz 1,5s 
44	Sweeping, IMO 3d, Germany KTA3901 evacuation	1200Hz 1s 500Hz 1s 
45	Sweeping	1200Hz 3s 500Hz 3s 
46	Sweeping, Finland General Alarm	1500Hz 7s 500Hz 7s 
52	Continuous	2400Hz ————
53	Continuous	2000Hz ————
54	Continuous, Finland All Clear	1500Hz ————
55	Continuous	1200Hz ————

(♫)	Beschreibung/ Description/ Descrizione/ Описание	
56	Continuous, PFEER (Gasalarm)	1000Hz ————
57	Continuous, UK BS5839-1	950Hz ————
59	Continuous	880Hz ————
60	Continuous	825Hz ————
61	Continuous	800Hz ————
63	Continuous	725Hz ————
65	Continuous, Sweden SS031711 (All Clear)	660Hz ————
66	Continuous	554Hz ————
67	Continuous, Germany KTA3901 (All Clear)	500Hz ————
68	Continuous	470Hz ————
69	Continuous	440Hz ————
71	Continuous	340Hz ————
77	Intermittent	2400Hz 
82	Intermittent, PFEER (General Alarm), UK BS5839-1 (Back-up Alarm)	1000Hz 
83	Intermittent, PFEER (General Alarm)	1000Hz 
88	Intermittent	950Hz 
90	Intermittent	825Hz 
91	Intermittent	800Hz 
92	Intermittent	800Hz 
93	Intermittent (fast), electromechanical horn	800Hz 
97	Intermittent	725Hz 
98	Intermittent, Sweden SS 031711 (Imminent Danger)	700Hz 
100	Intermittent, Industrial Alarm (Germany)	680Hz 
101	Intermittent, Sweden SS031711 (Important Message (Pre Mess))	660Hz 
102	Intermittent, Sweden SS031711 (Local Warning)	660Hz 
103	Intermittent, Sweden SS031711 (Air Raid)	660Hz 
104	Intermittent, Sweden SS031711 (Imminent Danger)	660Hz 
107	Intermittent, Germany KTA3901 (evacuation)	500Hz 
109	Intermittent, Australia AS2220, AS1610, AS1670	420Hz 
110	Intermittent (fast variable), Bell	1450Hz 
111	Intermittent, ISO8201 (emergency evacuation signal), USA (evacuation)	470Hz 
112	Intermittent, ISO8201 (emergency evacuation signal)	950Hz 
113	Intermittent, ISO8201 (emergency evacuation signal) treble tone	2850Hz 

Anhang/ Appendix/ Annexe/ Appendice/ Приложение

Grund-Ton-Nr. (J)	Beschreibung/ Description/ Descrizione/ Описание	
115	Intermittent, IMO (Telefon Call)	950Hz
116	Intermittent, IMO (abandon ship)	950Hz
117	Intermittent, IMO SOLAS III/50 + SOLAS III/6.4 (General Alarm)	825Hz
122	Alternating	2900Hz
123	Alternating	2900Hz 2400Hz
124	Alternating, Singapore	2000Hz 1000Hz
125	Alternating	1400Hz 1200Hz
128	Alternating	1025Hz 825Hz
130	Alternating, UK BS5839-1 (Fire Alarm)	1000Hz 800Hz
131	Alternating, UK BS5839-1 (Fire Alarm, Level crossing)	1000Hz 800Hz
135	Alternating, UK BS5839-1 (Fire Alarm, increased urgency - Level crossing)	1000Hz 800Hz
142	Alternating	900Hz 500Hz
143	Alternating, Germany Industrial Alarm	660Hz 440Hz
144	Alternating	650Hz 440Hz
146	Alternating, France NFS 32-001 (fire alarm)	554Hz 440Hz
147	Alternating, Sweden SS031711 (turn out)	554Hz 440Hz
148	Alternating, Sweden SS031711 (turn out)	554Hz 440Hz
152	Alternating-intermittent	800Hz 650Hz 2s

Ansteuerung der Töne/ Selection of the tones/ Activation des sons/ Controllo dei toni / Управление звуко-выми тонами

Tonartenschalter/ Selector -switch (Einstellung des Grundtones/ Adjusting the base tone)						External Tone Control			
1	2	3	4	5	6	Grund-Ton No. (J)	C1	C2	C1+C2
						1	2	88	57
ON						2 *	128	112	57
	ON					2	26	100	93
ON	ON					2	61	131	112
		ON				9	57	11	82
ON		ON				15	131	52	112
	ON	ON				16	109	52	56
ON	ON	ON				18	111	57	68
			ON			22	16	109	68
ON			ON			23	131	52	112
	ON		ON			24	131	52	131
ON	ON		ON			25	131	52	92
		ON	ON			26	2	100	93

Tonartenschalter/ Selector -switch (Einstellung des Grundtones/ Adjusting the base tone)							External Tone Control		
1	2	3	4	5	6	Grund-Ton No. (J)	Tone No.	Tone No.	Tone No.
ON		ON	ON			27	123	52	92
	ON	ON	ON			29	35	52	61
ON	ON	ON	ON			30	27	52	77
				ON		31	131	52	57
ON				ON		33	30	52	35
	ON			ON		34	35	52	93
ON	ON			ON		35	27	52	110
		ON		ON		36	146	67	57
ON		ON		ON		43	131	52	91
	ON	ON		ON		45	2	57	93
ON	ON	ON		ON		52	15	65	82
			ON	ON		54	46	54	131
ON			ON	ON		55	131	52	128
	ON		ON	ON		56	82	35	33
ON	ON		ON	ON		59	143	59	101
		ON	ON	ON		60	131	52	125
ON		ON	ON	ON		65	131	52	93
	ON	ON	ON	ON		66	110	52	107
ON	ON	ON	ON	ON		69	131	52	110
				ON		71	131	52	93
ON					ON	77	61	52	122
	ON				ON	82	131	52	83
ON	ON				ON	83	56	2	82
		ON			ON	88	2	57	128
ON		ON			ON	90	131	52	125
	ON	ON			ON	91	30	52	110
ON	ON	ON			ON	92	33	52	57
			ON		ON	93	2	128	57
ON			ON		ON	97	2	63	93
	ON		ON		ON	100	131	52	125
ON	ON		ON		ON	101	98	102	65
		ON	ON		ON	103	131	65	147
ON		ON	ON		ON	104	103	65	101
	ON	ON	ON		ON	109	16	52	22
ON	ON	ON	ON		ON	110	131	61	91
				ON	ON	112	2	57	128
ON				ON	ON	113	52	123	104
	ON			ON	ON	115	117	116	44
ON	ON			ON	ON	116	117	93	125
		ON		ON	ON	117	93	116	125
ON		ON		ON	ON	123	27	52	77
	ON	ON		ON	ON	124	53	83	2
ON	ON	ON		ON	ON	130	2	107	67
			ON	ON	ON	131	2	112	57
ON			ON	ON	ON	135	16	56	109
	ON		ON	ON	ON	142	2	54	88
ON	ON		ON	ON	ON	143	59	93	33
		ON	ON	ON	ON	144	110	61	2
ON		ON	ON	ON	ON	146	31	67	57
	ON	ON	ON	ON	ON	148	131	52	92
ON	ON	ON	ON	ON	ON	152	110	61	13

* Werkseinstellung/ Factory setting/ Réglage d'usine/ Impostazione di fabbrica/ Заводская настройка



ELECTRO-TECHNOLOGY FOR INDUSTRY

Pfannenberg GmbH

Werner-Witt-Straße 1 • D- 21035 Hamburg

Tel.: +49/ (0)40/ 734 12-0 • Fax: +49/ (0)40/ 734 12-101

service@pfannenberg.com

http://www.pfannenberg.com